

SPECIFICATION **CSP1311Y2C**
PACKAGE OUTLINES

Notes:

1. All dimensions are in millimeters (inches).
2. Tolerance is ± 0.25 mm (0.01") unless otherwise noted.
3. Specifications are subject to change without notice.

Part Number	Chip Material	Color of Emission	Lens Type	Viewing Angle
CSP1311Y2C	InGaAlP	Yellow	Water Clear	120°

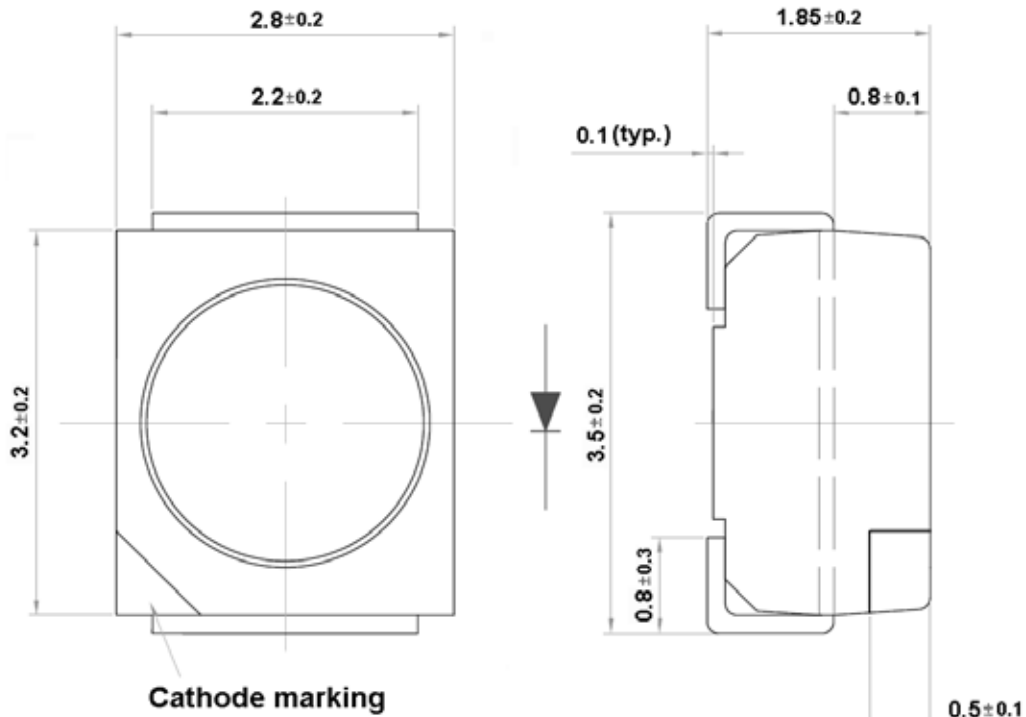

ChromeLED Corp. reserves the right to make changes at any time in order to supply the best product possible. The most current version of this document will always be available at: www.chromeled.com

ABSOLUTE MAXIMUM RATINGS
(TA=25°C)

Parameter	Symbol	Max Rating	Unit
Forward Current	I _F	30	mA
Reverse Current @ 5V	I _R	10	μA
Power Dissipation	P _d	75	mW
Operating Temperature Range	T _{OP}	-40~+100	°C
Storage Temperature Range	T _{STG}	-40~+100	°C
Peak Pulsing Current (1/10 duty f = 10KHz)	I _{FP}	100	mA
Soldering Temperature	T _{SOL}	Max 260°C for 5 sec Max	

OPTICAL-ELECTRICAL CHARACTERISTICS
(TA=25°C)

Parameter	Symbol	Test Condition	Value			Unit
			Min	Typ	Max	
Luminous Intensity	I _v	I _F = 20mA	180	450	-	mcd
Forward Voltage	V _F	I _F = 20mA	-	1.8	2.3	V
Reverse Leakage Current	I _R	V _R = 5V	-	-	10	μA
Viewing Angle at 50% I _v	2θ _{1/2}	I _F = 20mA	-	120	-	Deg
Peak Wavelength	λ _P	I _F = 20mA	-	594	-	nm
Dominant Wavelength	λ _D	I _F = 20mA	-	587	-	nm

*Tolerance of viewing angle: -10 / +5 deg.



ChromeLED Corp. reserves the right to make changes at any time in order to supply the best product possible. The most current version of this document will always be available at: www.chromeled.com

RECOMMENDED SOLDER PAD

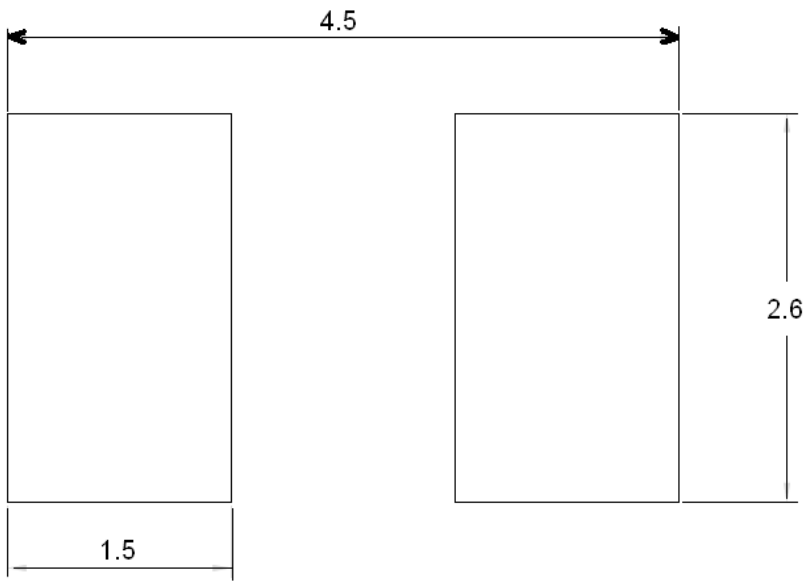

Additional Cu area for improved heat dissipation > 16mm sq.

 Solder resist

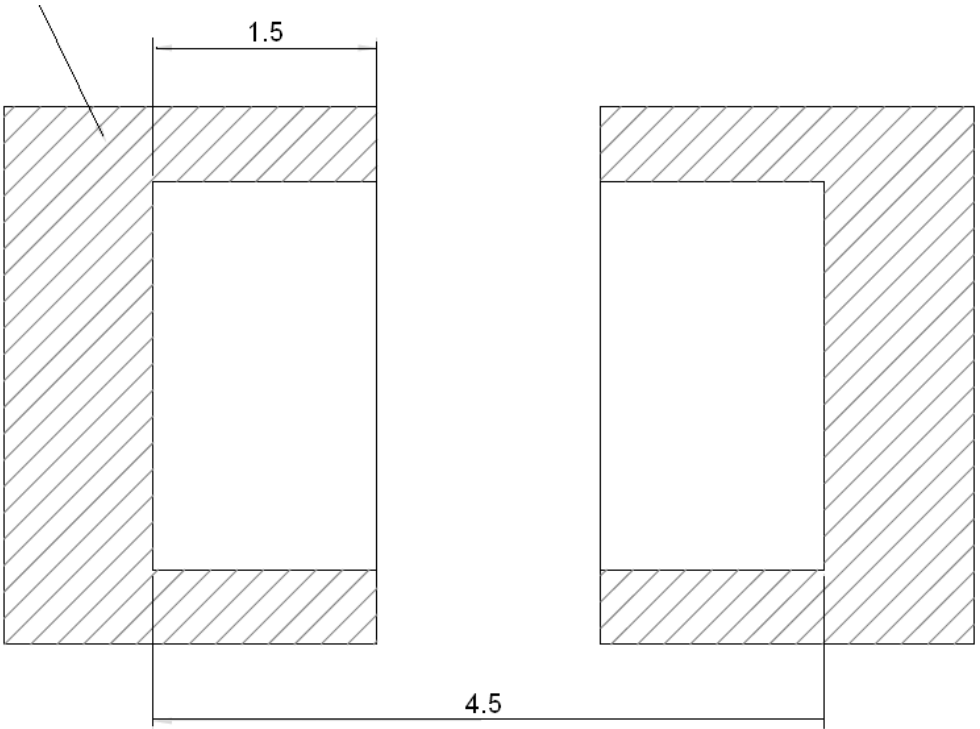

ChromeLED Corp. reserves the right to make changes at any time in order to supply the best product possible. The most current version of this document will always be available at: www.chromeled.com

OPTICAL CHARACTERISTIC CURVES

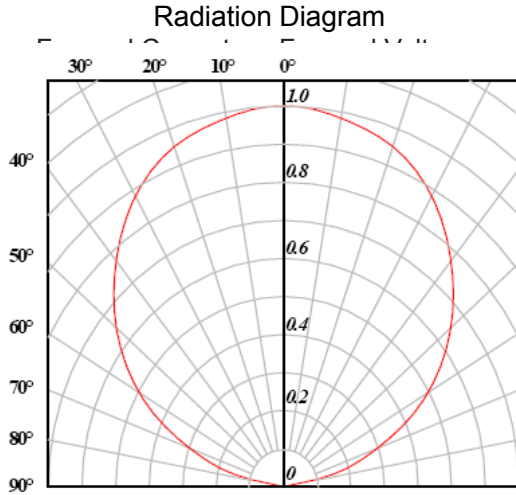

Relative Intensity vs. Forward Current

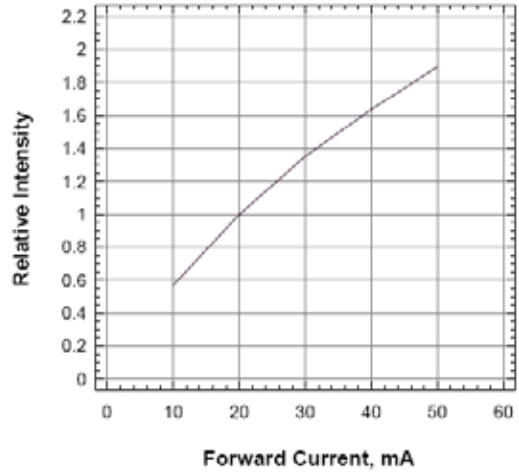

Max Forward Current vs. Temp

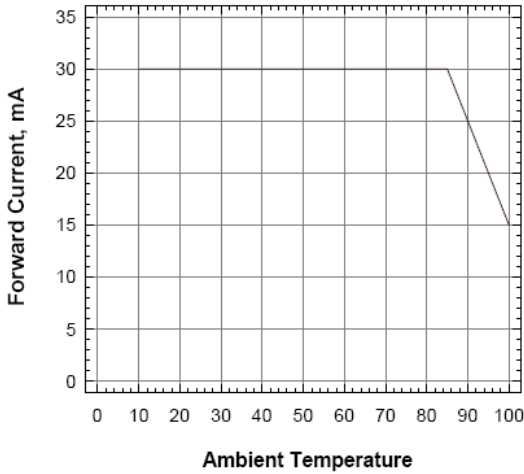

Forward Current vs. Forward Voltage

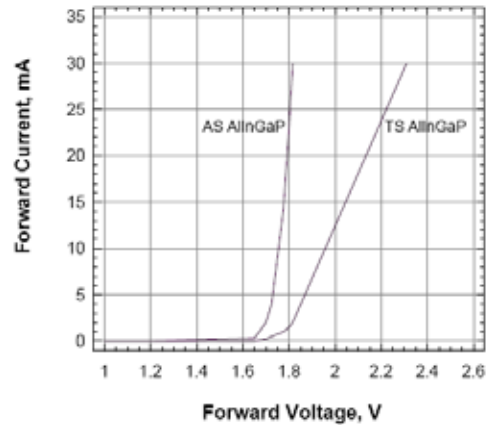

Relative Intensity vs. Wavelength

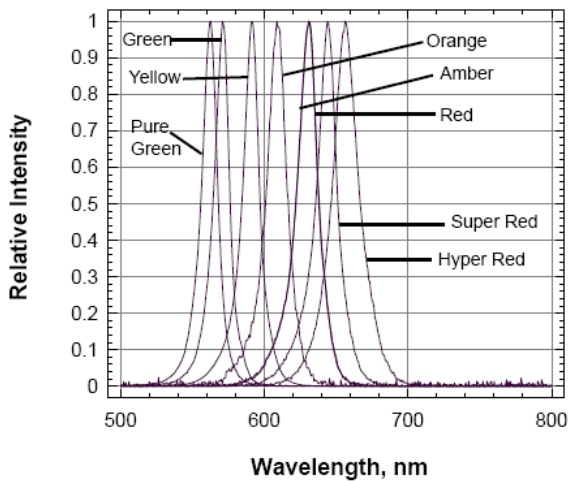

ChromeLED Corp. reserves the right to make changes at any time in order to supply the best product possible. The most current version of this document will always be available at: www.chromeled.com

SOLDERING CONDITIONS

RECOMMENDED Sn-PB IR-Reflow Soldering Profile



RECOMMENDED Pb-Free Soldering Profile



ChromeLED Corp. reserves the right to make changes at any time in order to supply the best product possible. The most current version of this document will always be available at: www.chromeled.com

PACKAGING SPECIFICATION

TAPING SPECIFICATIONS

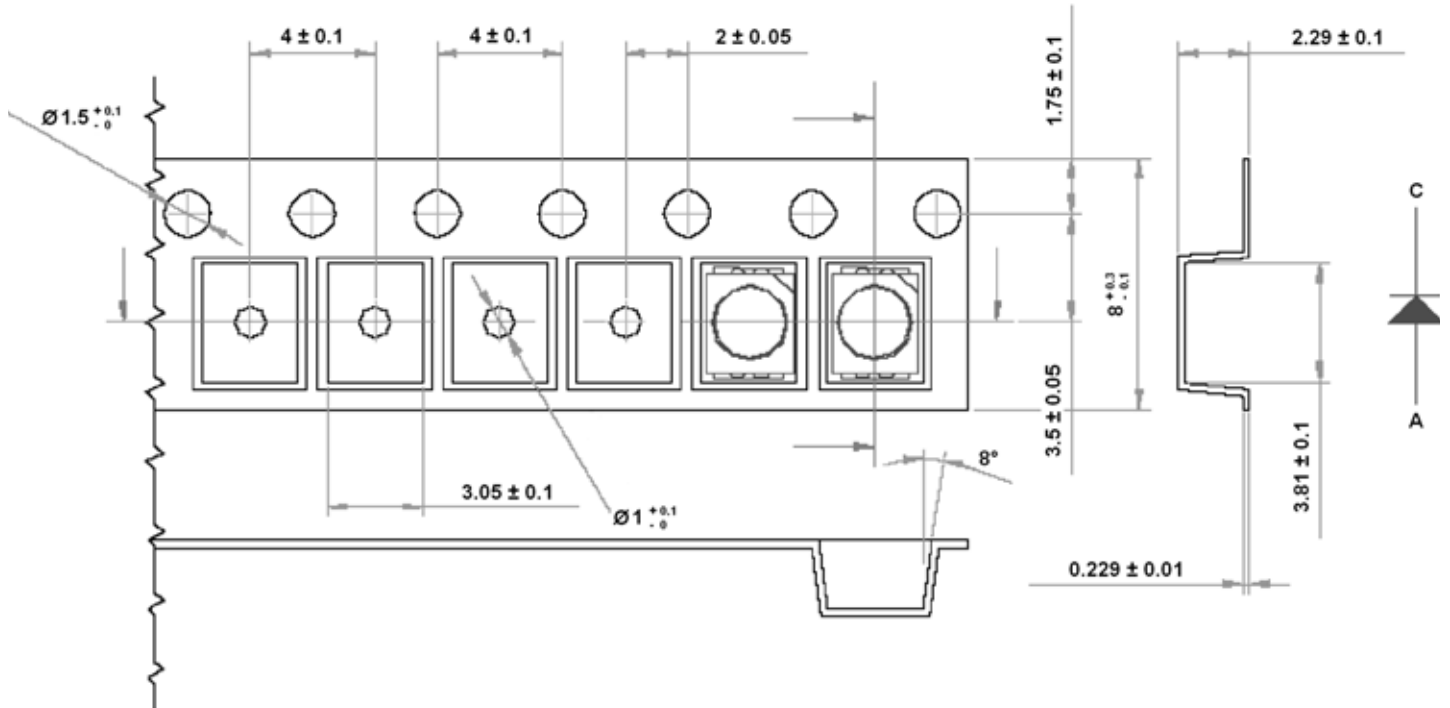

Notes: Reel packaging is 2000pcs/reel or 8000pcs/reel. Reel diameters are 180mm and 330mm respectively.

TAPING ORIENTATION

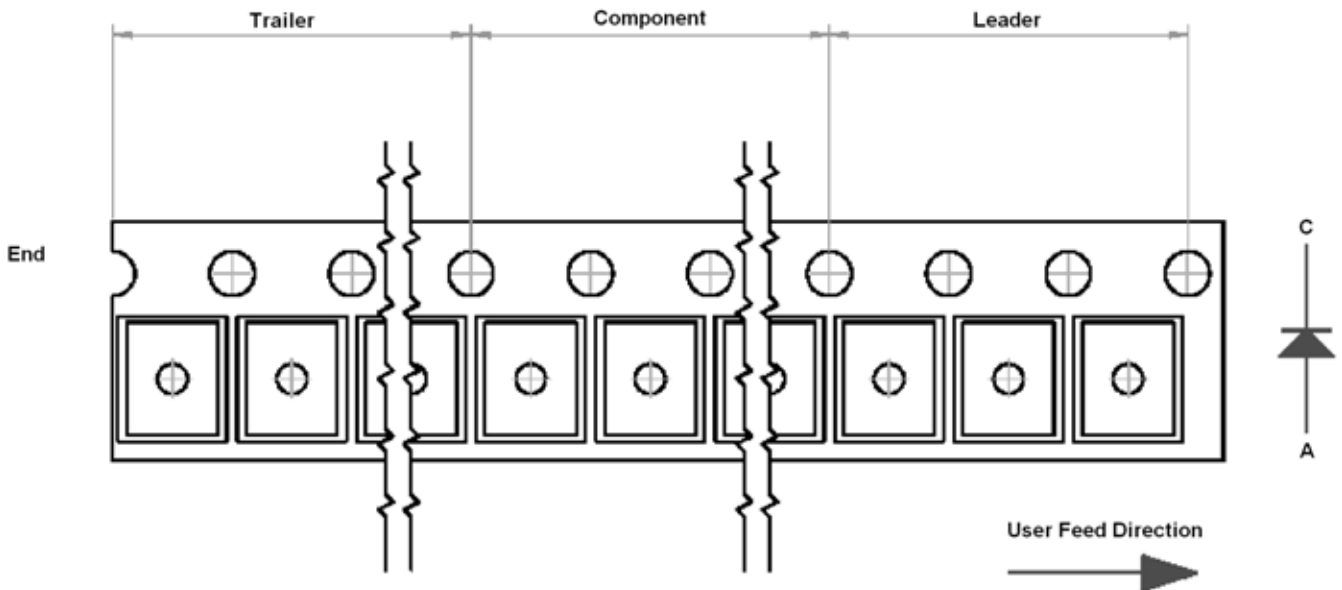

- Notes:
- 1) 200mm min for Ø180 and Ø330 reel
 - 2) 480mm min for Ø180 reel
 - 3) 960mm min for Ø330 reel



ChromeLED Corp. reserves the right to make changes at any time in order to supply the best product possible. The most current version of this document will always be available at: www.chromeled.com