

SPECIFICATION **CSP1311W3ZC**
PACKAGE OUTLINES

- Notes:
1. All dimensions are in millimeters (inches).
 2. Tolerance is $\pm 0.25\text{mm}$ ($0.01''$) unless otherwise noted.
 3. Specifications are subject to change without notice.

Part Number	Chip Material	Color of Emission	Lens Type	Viewing Angle
CSP1311W3ZC	InGaN	White	Yellow	120°

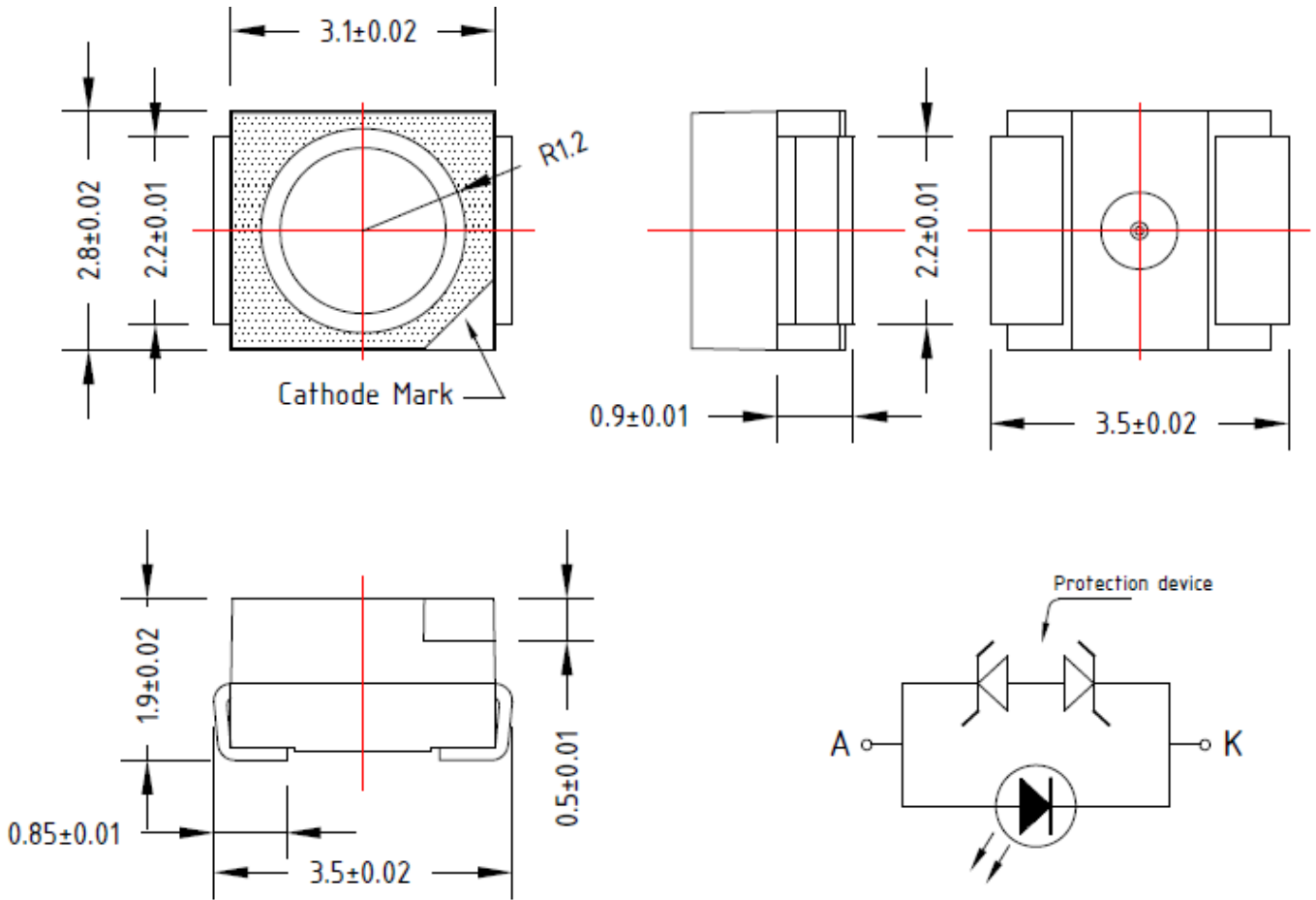

ChromeLED Corp. reserves the right to make changes at any time in order to supply the best product possible. The most current version of this document will always be available at: www.chromeled.com

ABSOLUTE MAXIMUM RATINGS
(TA=25°C)

Parameter	Symbol	Max Rating	Unit
Forward Current	I _F	20	mA
Reverse Current @ 5V	I _R	10	μA
Power Dissipation	P _d	80	mW
Operating Temperature Range	T _{OP}	-40~+100	°C
Storage Temperature Range	T _{STG}	-40~+100	°C
Peak Pulsing Current (1/10 duty f = 10KHz)	I _{FP}	100	mA
Soldering Temperature	T _{SOL}	Max 260°C for 5 sec Max	

OPTICAL-ELECTRICAL CHARACTERISTICS
(TA=25°C)

Parameter	Symbol	Test Condition	Value			Unit
			Min	Typ	Max	
Luminous Intensity	I _v	I _F = 20mA	2000	2600	-	mcd
Forward Voltage	V _F	I _F = 20mA	-	3.2	3.6	V
Reverse Leakage Current	I _R	V _R = 5V	-	-	10	μA
Viewing Angle at 50% I _v	2θ _{1/2}	I _F = 20mA	-	120	-	Deg
Chromaticity Coordinate	X	I _F = 20mA	-	0.31	-	-
Chromaticity Coordinate	Y	I _F = 20mA	-	0.32	-	-

*Tolerance of viewing angle: -10 / +5 deg.



ChromeLED Corp. reserves the right to make changes at any time in order to supply the best product possible. The most current version of this document will always be available at: www.chromeled.com

RADIATION PATTERN & RECOMMENDED SOLDER PAD

Radiation Pattern

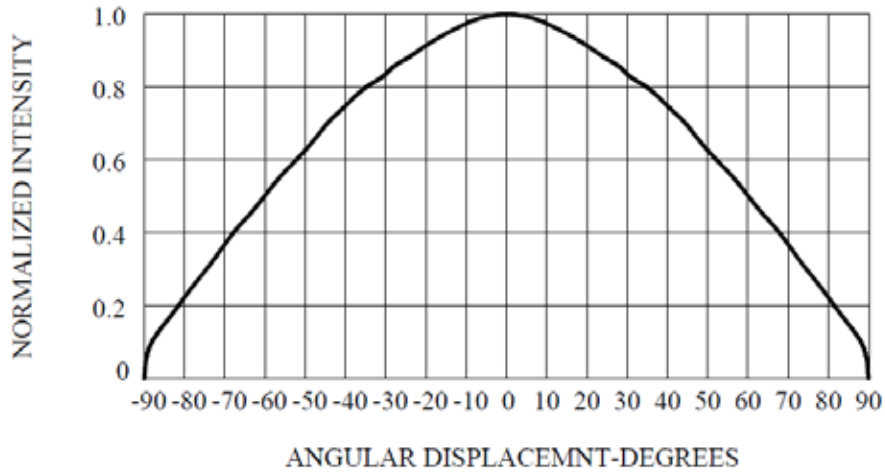

Recommended Soldering Pad Pattern

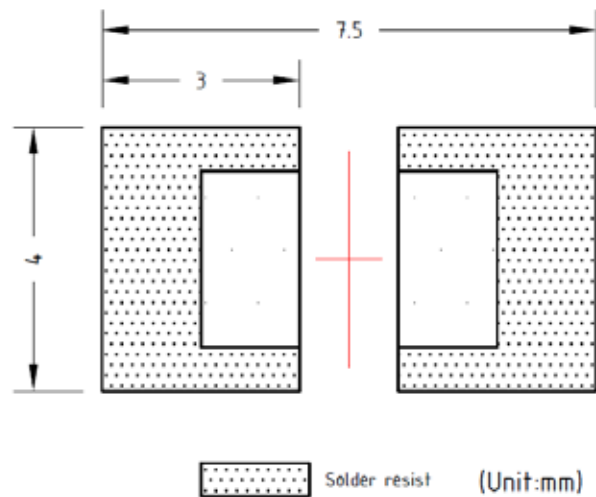
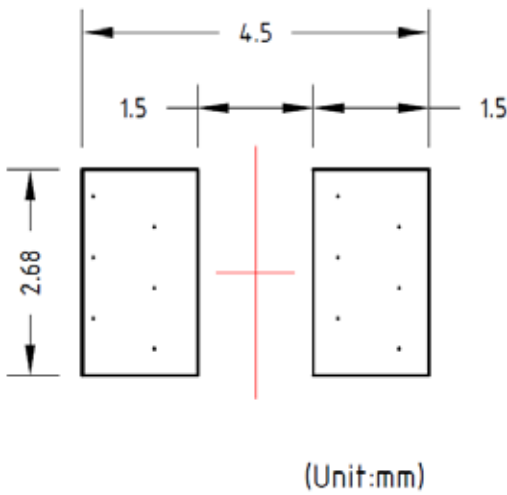

ChromeLED Corp. reserves the right to make changes at any time in order to supply the best product possible. The most current version of this document will always be available at: www.chromeled.com

OPTICAL CHARACTERISTIC CURVES

Relative Luminous Intensity Vs Forward Current

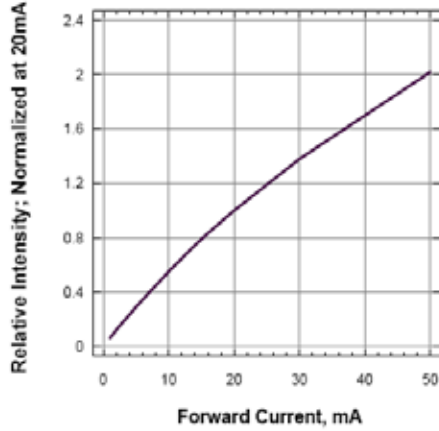

Forward Current Vs Forward Voltage

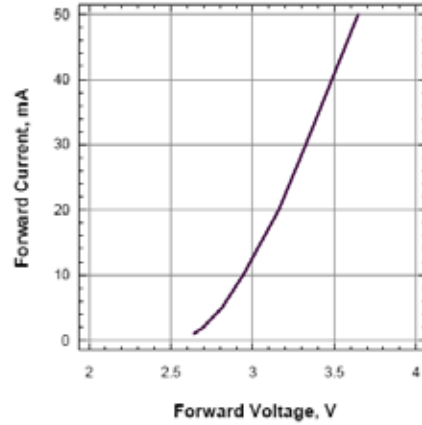

Maximum Current Vs Ambient Temperature

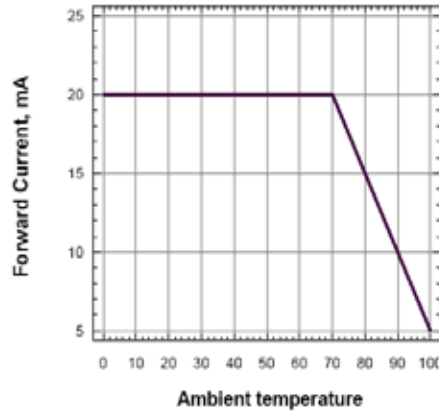

Relative Intensity Vs. Wavelength

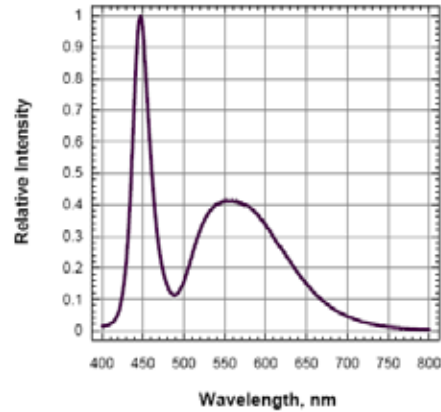

Radiation Pattern

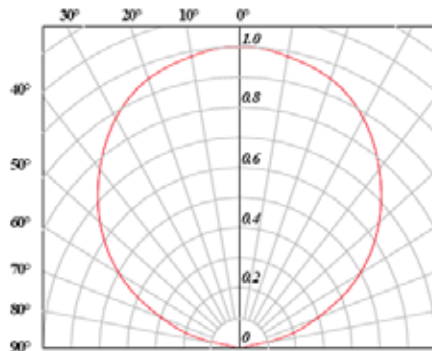

ChromeLED Corp. reserves the right to make changes at any time in order to supply the best product possible. The most current version of this document will always be available at: www.chromeled.com

SOLDERING CONDITIONS

RECOMMENDED Sn-PB IR-Reflow Soldering Profile



RECOMMENDED Pb-Free Soldering Profile

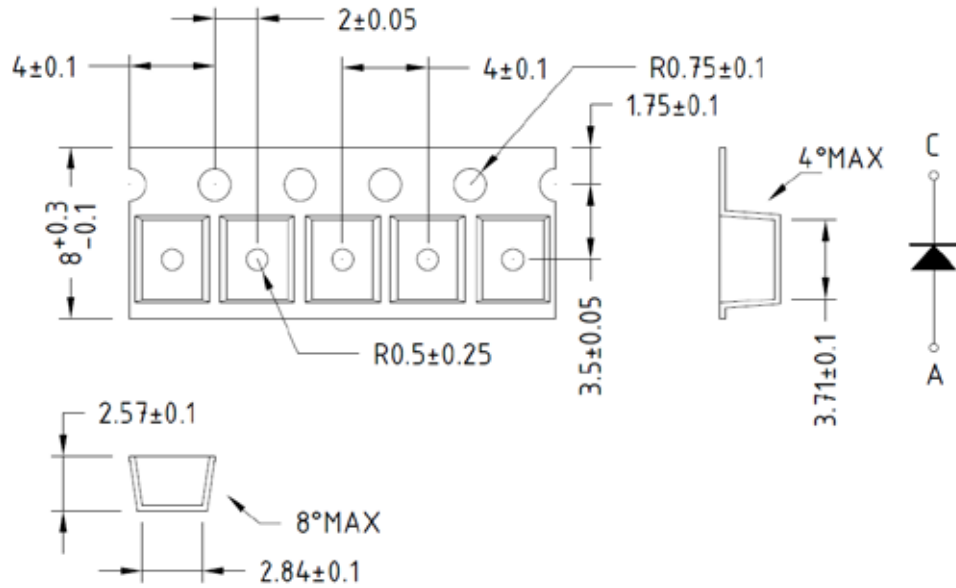
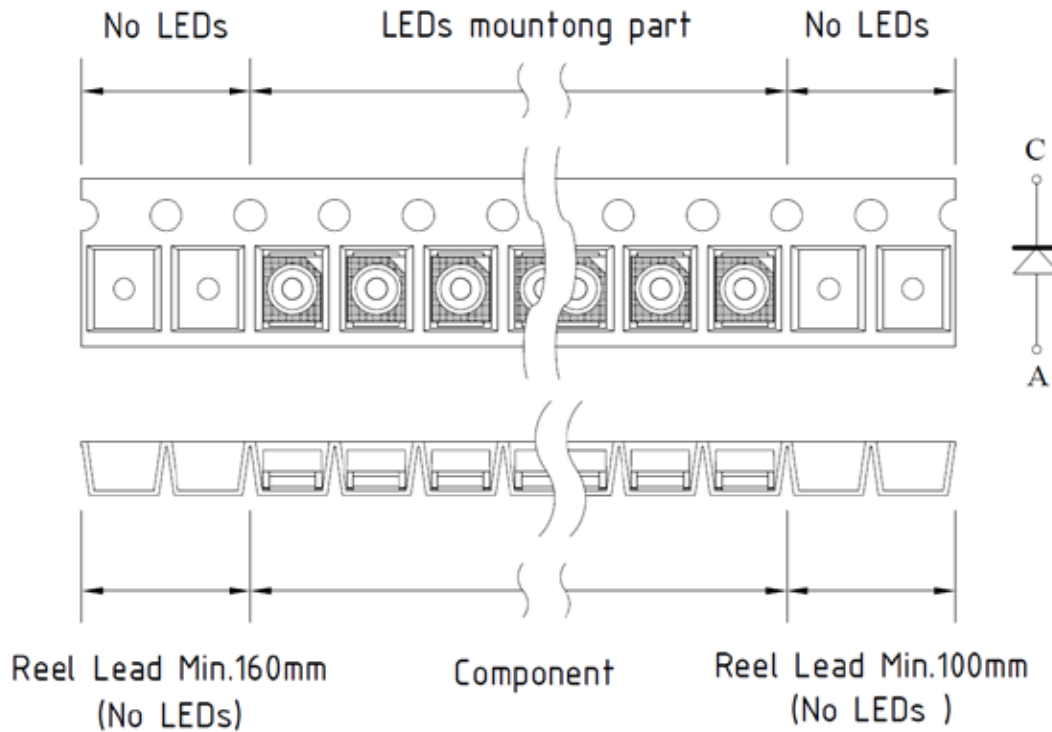

ChromeLED Corp. reserves the right to make changes at any time in order to supply the best product possible. The most current version of this document will always be available at: www.chromeled.com

PACKAGING SPECIFICATION
Tape Dimension

Tape Leader and Trailer Dimension

ChromeLED Corp. reserves the right to make changes at any time in order to supply the best product possible. The most current version of this document will always be available at: www.chromeled.com