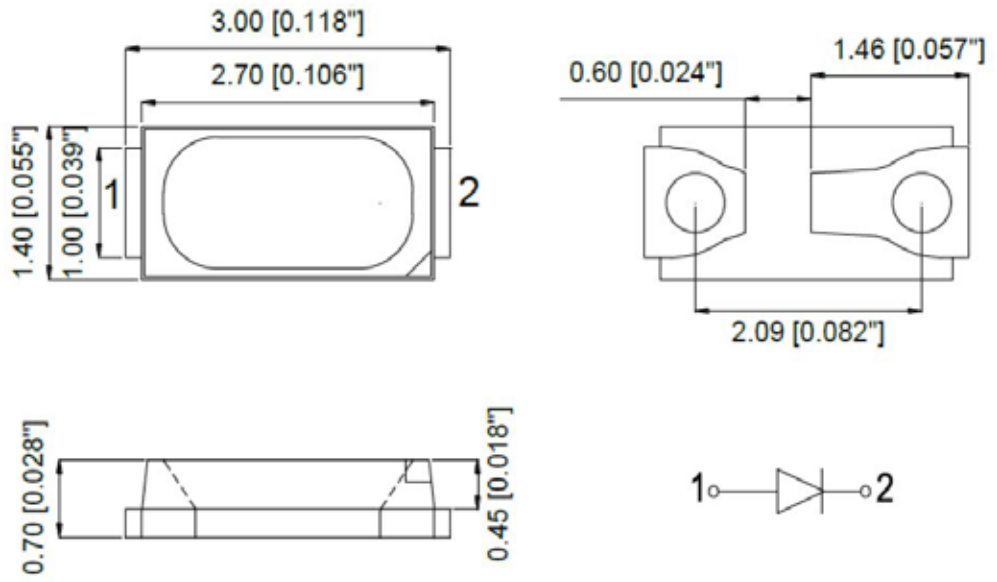
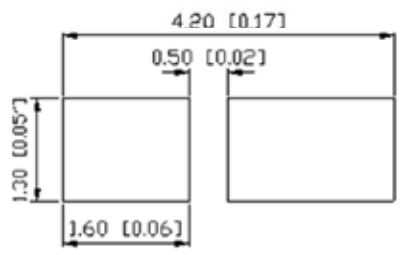

SPECIFICATION **CSP125R4C**
PACKAGE OUTLINES

RECOMMENDED PAD LAYOUT

ITEM	MATERIALS
Resin	Silicon
Lens Color	Water Transparent
Dice	AlGaInP
Emitted Color	Red

- Notes:
1. All dimensions are in millimeters (inches).
 2. Tolerance is $\pm 0.25\text{mm}$ (0.01") unless otherwise noted.
 3. Specifications are subject to change without notice.

Part Number	Chip Material	Color of Emission	Lens Type	Viewing Angle
CSP125R4C	InGaAlP	Red	Water Clear	120°



ChromeLED Corp. reserves the right to make changes at any time in order to supply the best product possible. The most current version of this document will always be available at: www.chromeled.com

ABSOLUTE MAXIMUM RATINGS
(TA=25°C)

Parameter	Symbol	Max Rating	Unit
Forward Current	IF	30	mA
Reverse Current @ 5V	IR	10	μA
Operating Temperature Range	TOP	-40~+80	°C
Storage Temperature Range	TSTG	-40~+80	°C
Peak Pulsing Current (1/8 duty f = 1KHz)	IFP	125	mA
Soldering Temperature	TSOL	Max 260°C for 5 sec Max	

OPTICAL-ELECTRICAL CHARACTERISTICS
(TA=25°C)

Parameter	Symbol	Test Condition	Value			Unit
			Min	Typ	Max	
Luminous Intensity	Iv	IF = 20mA	250	430	800	Mcd
Forward Voltage	VF	IF = 20mA	1.7	2.0	2.5	V
Reverse Leakage Current	IR	VR = 5V	-	-	10	μA
Viewing Angle at 50% Iv	2θ1/2	IF = 20mA	-	120	-	Deg
Peak Wavelength	λP	IF = 20mA	-	631	-	nm
Dominant Wavelength	λD	IF = 20mA	615	620	630	nm
Spectral Half Bandwidth	Δλ	IF = 20mA	-	19	-	nm

*Tolerance of viewing angle: -10 / +5 deg.



ChromeLED Corp. reserves the right to make changes at any time in order to supply the best product possible. The most current version of this document will always be available at: www.chromeled.com

OPTICAL CHARACTERISTIC CURVES

Relative Intensity vs. Wavelength

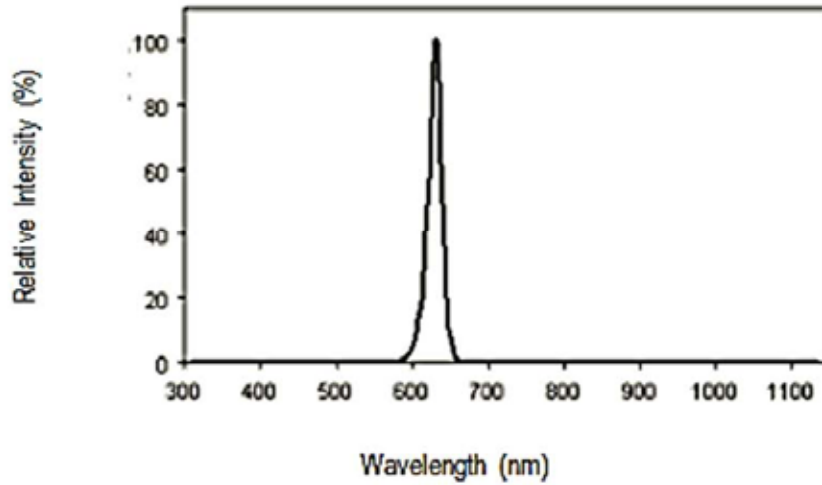

Forward Current vs. Forward Voltage

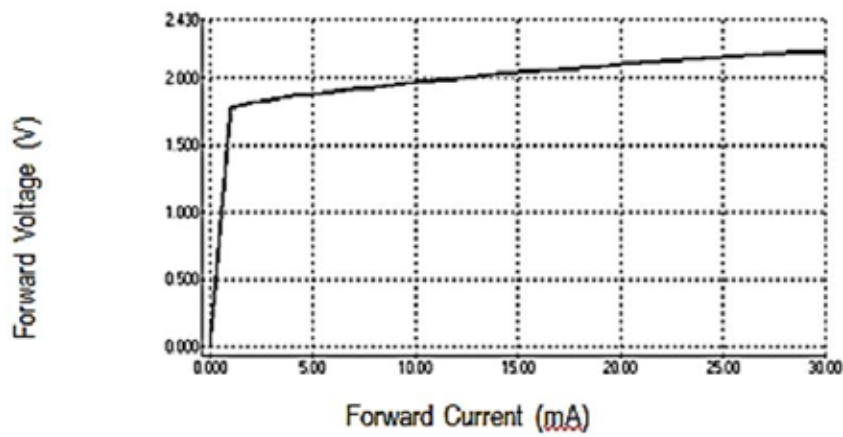

Directive Characteristics

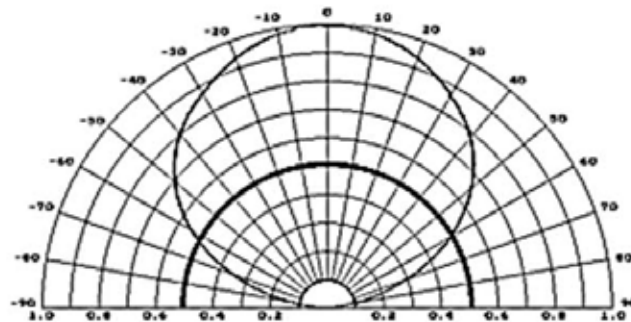

ChromeLED Corp. reserves the right to make changes at any time in order to supply the best product possible. The most current version of this document will always be available at: www.chromeled.com

PACKAGING SPECIFICATION

PACKAGING SPECIFICATION

Feeding Direction

Dimensions of Reel (Unit: mm)

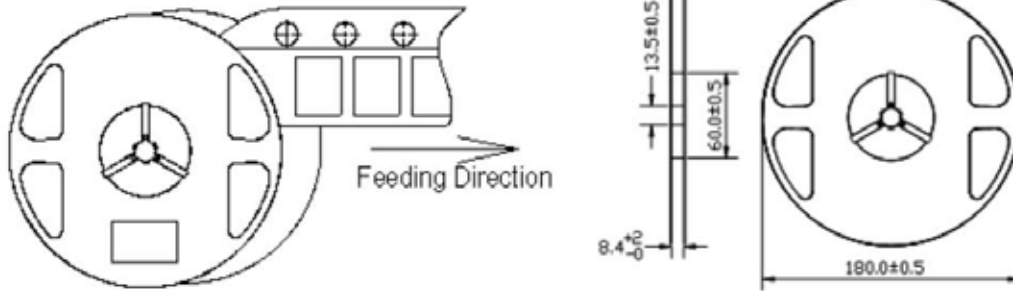

Dimensions of Tape (Unit: mm)

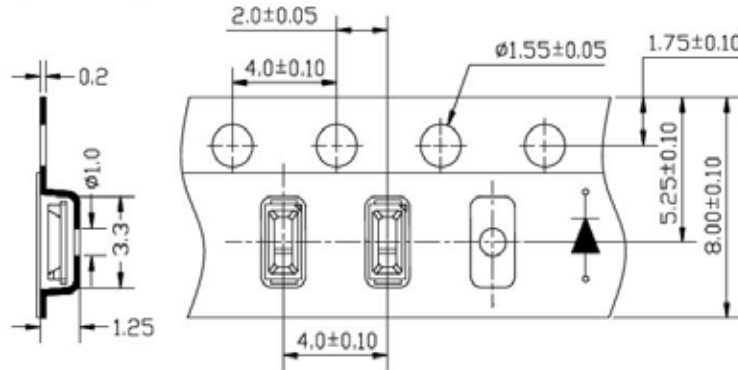

Arrangement of Tape

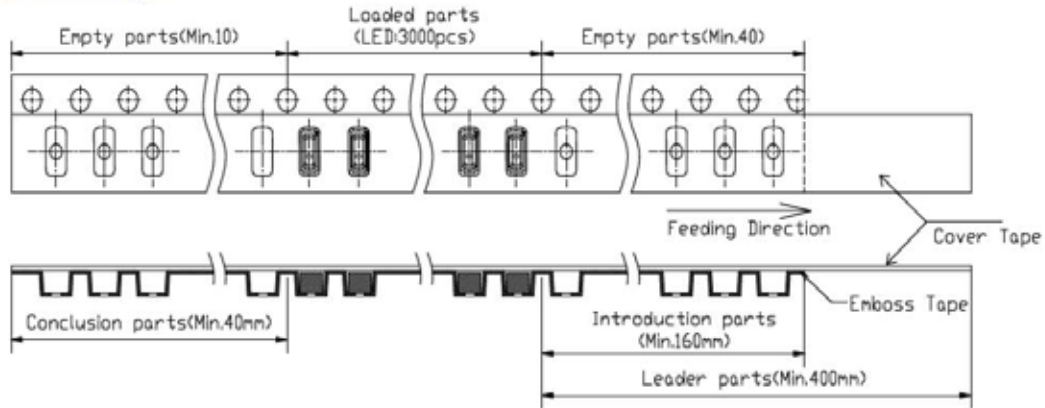

Notes:

1. Empty component pockets are sealed with top cover tape;
2. The maximum number of missing lamps is two;
3. The cathode is oriented towards the tape sprocket hole.
4. 3,000pcs/Reel



ChromeLED Corp. reserves the right to make changes at any time in order to supply the best product possible. The most current version of this document will always be available at: www.chromeled.com

SOLDERING CONDITIONS

REFLOW PROFILE

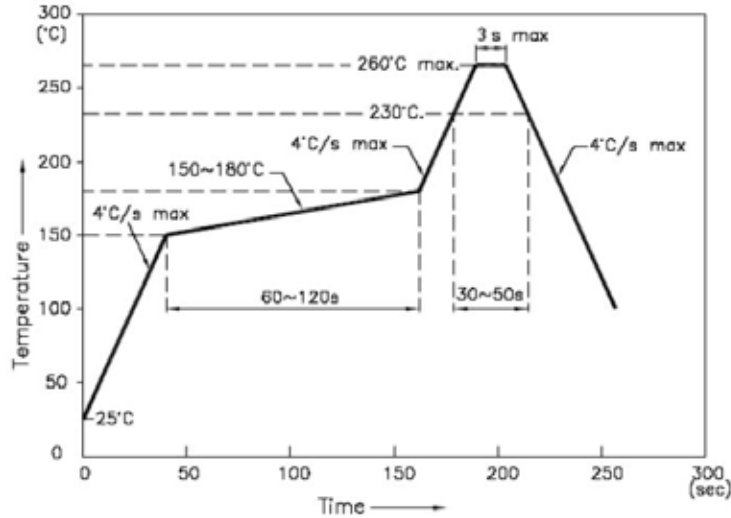

NOTES:

1. We recommend the reflow temperature 245°C (±5°C). The maximum soldering temperature should be limited to 260°C.
2. Don't cause stress to the epoxy resin while it is exposed to high temperature.
3. Number of reflow process shall be 2 times or less.

SOLDERING IRON

Basic spec is ≤ 5sec when 260°C. If temperature is higher, time should be shorter (+10°C → -1sec). Power dissipation of iron should be smaller than 20W, and temperatures should be controllable. Surface temperature of the device should be under 230°C.

REWORK

1. Customer must finish rework within 5 sec under 260°C.
2. The head of iron cannot touch copper foil
3. Twin-head type is preferred.

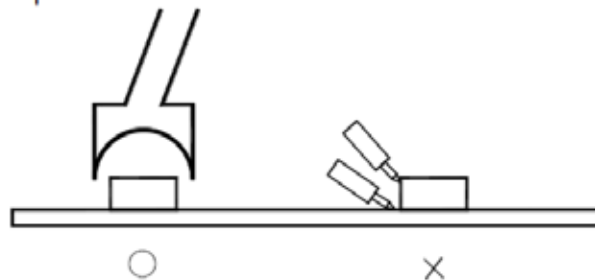

ChromeLED Corp. reserves the right to make changes at any time in order to supply the best product possible. The most current version of this document will always be available at: www.chromeled.com