

SPECIFICATIONS **CL50G2D**

OUTLINES DIMENSIONS

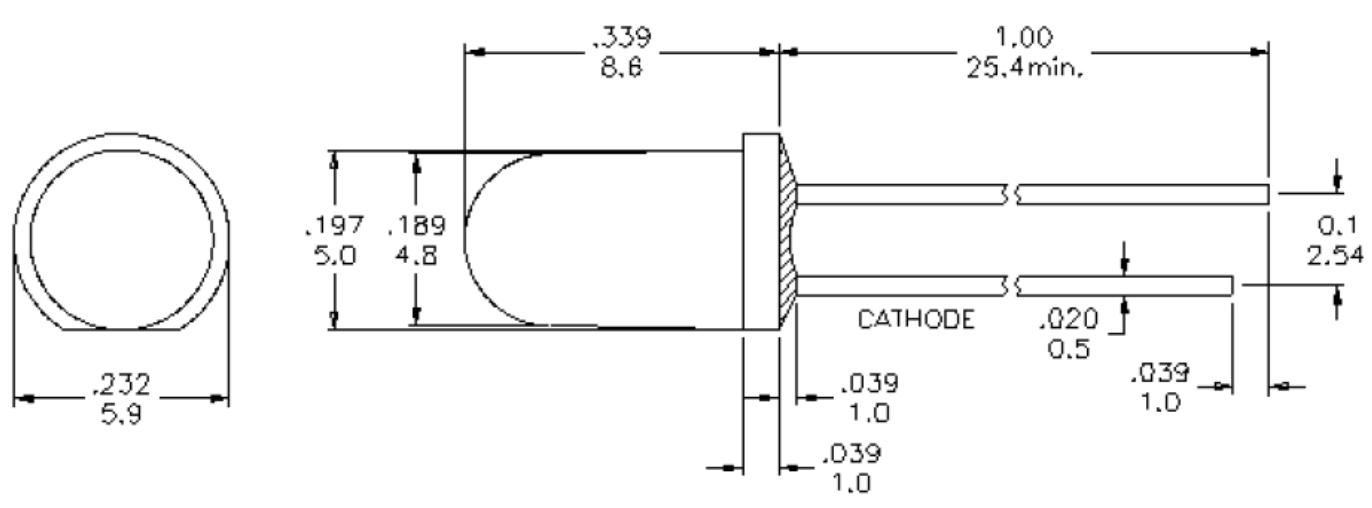

The technical drawing shows the following dimensions:

- Top View:** Diameter is .232 (5.9).
- Side View:**
 - Distance from the left edge to the start of the lens: .339 (8.6)
 - Distance from the start of the lens to the right edge: 1.00 (25.4 min.)
 - Distance from the left edge to the center of the lens: .189 (4.8)
 - Distance from the left edge to the top of the lens: .197 (5.0)
 - Distance from the center of the lens to the right edge: .039 (1.0)
 - Distance from the center of the lens to the bottom of the lens: .039 (1.0)
 - Distance from the right edge to the center of the cathode: .020 (0.5)
 - Distance from the right edge to the center of the anode: .039 (1.0)
 - Distance from the right edge to the top of the cathode: 0.1 (2.54)
 - Distance from the right edge to the top of the anode: 0.1 (2.54)

Notes:

1. All Dimensions are in millimeters (inches).
2. Tolerance is $\pm 0.25\text{mm}$ (0.01") unless otherwise noted.
3. Specifications are subject to change without notice.

Part Number	Chip Material	Color of Emission	Lens Type	Viewing Angle
CL50G2D	InGaAlP	Green	Green Diffused	45°



ChromeLED Corp. reserves the right to make changes at any time in order to supply the best product possible. The most current version of this document will always be available at: www.chromeled.com

ABSOLUTE MAXIMUM RATINGS
(TA=25°C)

Parameter	Symbol	Max Rating	Unit
Power Dissipation	PD	72	mW
Pulse Current Forward Current	IFP	100	mA
Continuous Forward Current	IF	30	mA
Reverse Voltage	VR	5	V
Operating Temperature Range	TOPR	-40~+80	°C
Storage Temperature Range	TSTG	-40~+100	°C
IFP = Pulse Width ≤ 10 ms, Duty Ratio ≤ 1/10. Soldering Condition: 260 °C/ 5sec			

OPTICAL-ELECTRICAL CHARACTERISTICS
(TA=25°C)

Parameter	Symbol	Test Condition	Value			Unit
			Min	Typ	Max	
Luminous Intensity	IV	IF = 20mA	18	50	-	mcd
Forward Voltage	VF	IF = 10mA	-	2.0	2.4	V
Reverse Leakage Current	IR	VR = 5V	-	-	50	μA
Viewing Angle	2θ1/2	IF = 10mA	-	45	-	deg
Dominant Wavelength	λD	IF = 10mA	-	570	-	nm

*Tolerance of viewing angle: -10 / +5 deg.



ChromeLED Corp. reserves the right to make changes at any time in order to supply the best product possible. The most current version of this document will always be available at: www.chromeled.com

OPTICAL CHARACTERISTIC CURVES

Fig 1. Forward Current vs. Forward Voltage

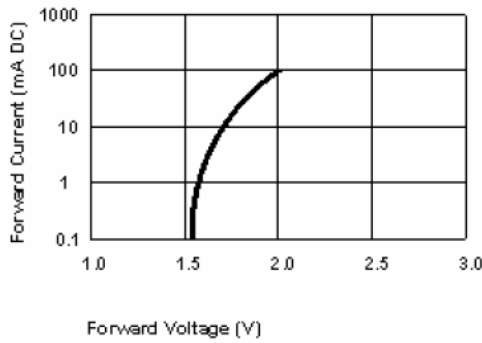

Fig 2. Relative Intensity vs. Forward Current

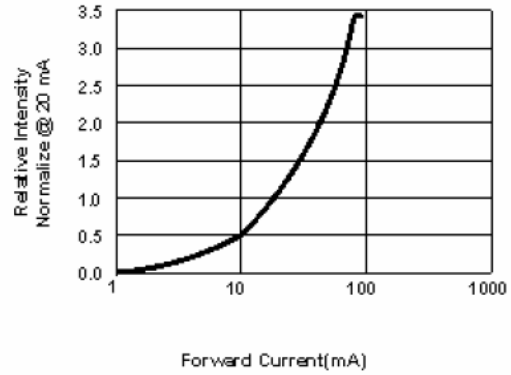

Fig 3. Forward Voltage vs. Temperature

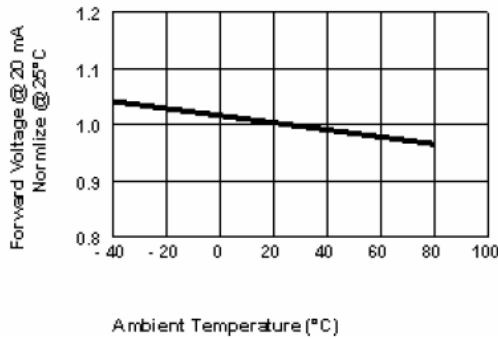

Fig 4. Relative Intensity vs. Temperature

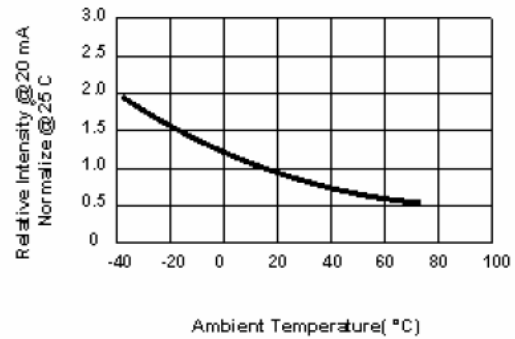

Fig5. Relative Intensity Vs. Wavelength

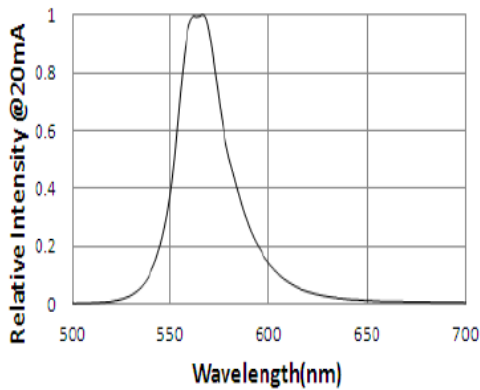
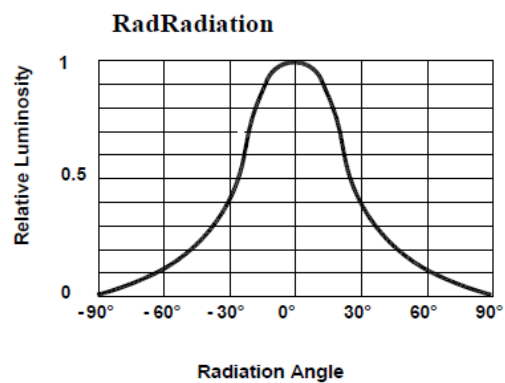

Fig6. Relative Luminous Intensity Vs.



ChromeLED Corp. reserves the right to make changes at any time in order to supply the best product possible. The most current version of this document will always be available at: www.chromeled.com

SOLDERING CONDITIONS – LAMP TYPE LED

PRECAUTION FOR USE

1. Recommended Soldering Condition

1.1 Wave Soldering

Basic spec is ≤ 5 sec. when 260°C . If temperature is higher, time should be shorter ($+10^{\circ}\text{C} \rightarrow -1$ sec).

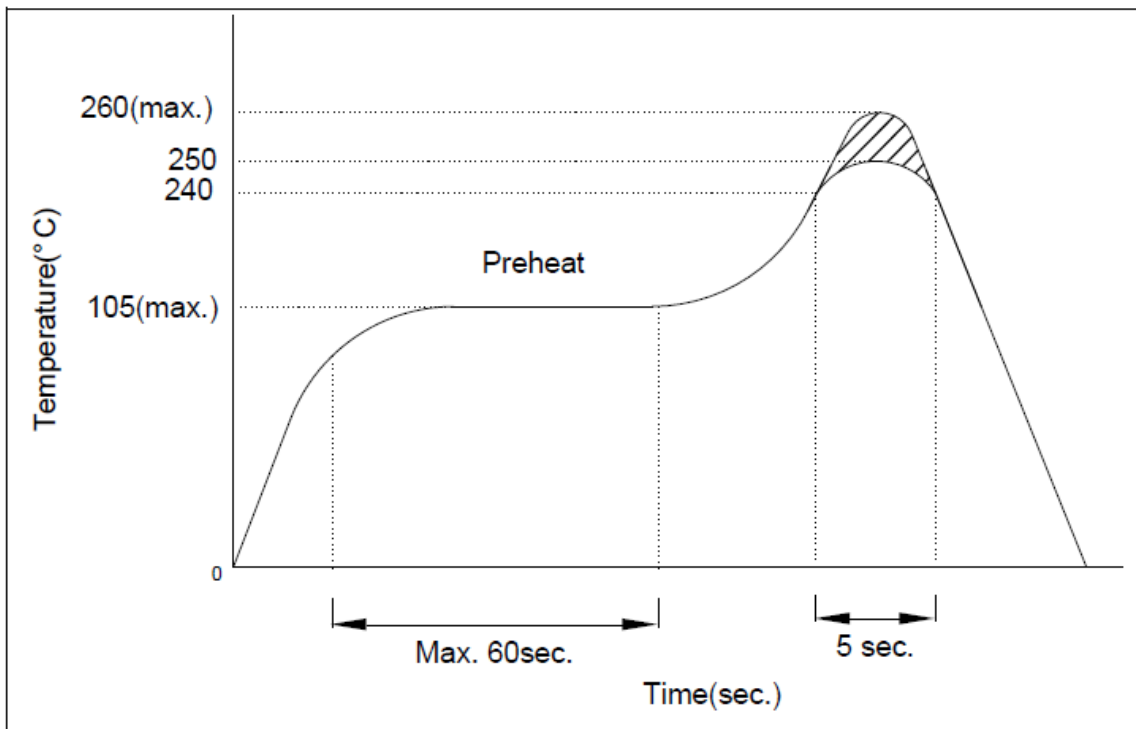

1.2 Soldering Iron

Power dissipation of iron should be smaller than 15W and temperature should be controllable. Surface temperature of iron tip should be under 230°C , soldering time ≤ 3 sec.

2. Electrostatic Discharge (ESD)

Static electricity or surge voltage will damage the LEDs.

Use of conductive wrist band or anti-electrostatic glove when handling these LEDs is recommended. All devices, equipment, work table, storage rack and machinery must be properly grounded.

In the events of manual working in process, make sure devices are well protected from ESD at all times.



ChromeLED Corp. reserves the right to make changes at any time in order to supply the best product possible. The most current version of this document will always be available at: www.chromeled.com