

SPECIFICATION **CSHF573NW2C**
PACKAGE OUTLINES

- Notes:
1. All dimensions are in millimeters (inches).
 2. Tolerance is $\pm 0.25\text{mm}$ (0.01") unless otherwise noted.
 3. Specifications are subject to change without notice.

Part Number	Chip Material	Color of Emission	Lens Type	Viewing Angle
CSHF573NW2C	InGaN	White	Yellow Diffused	120°

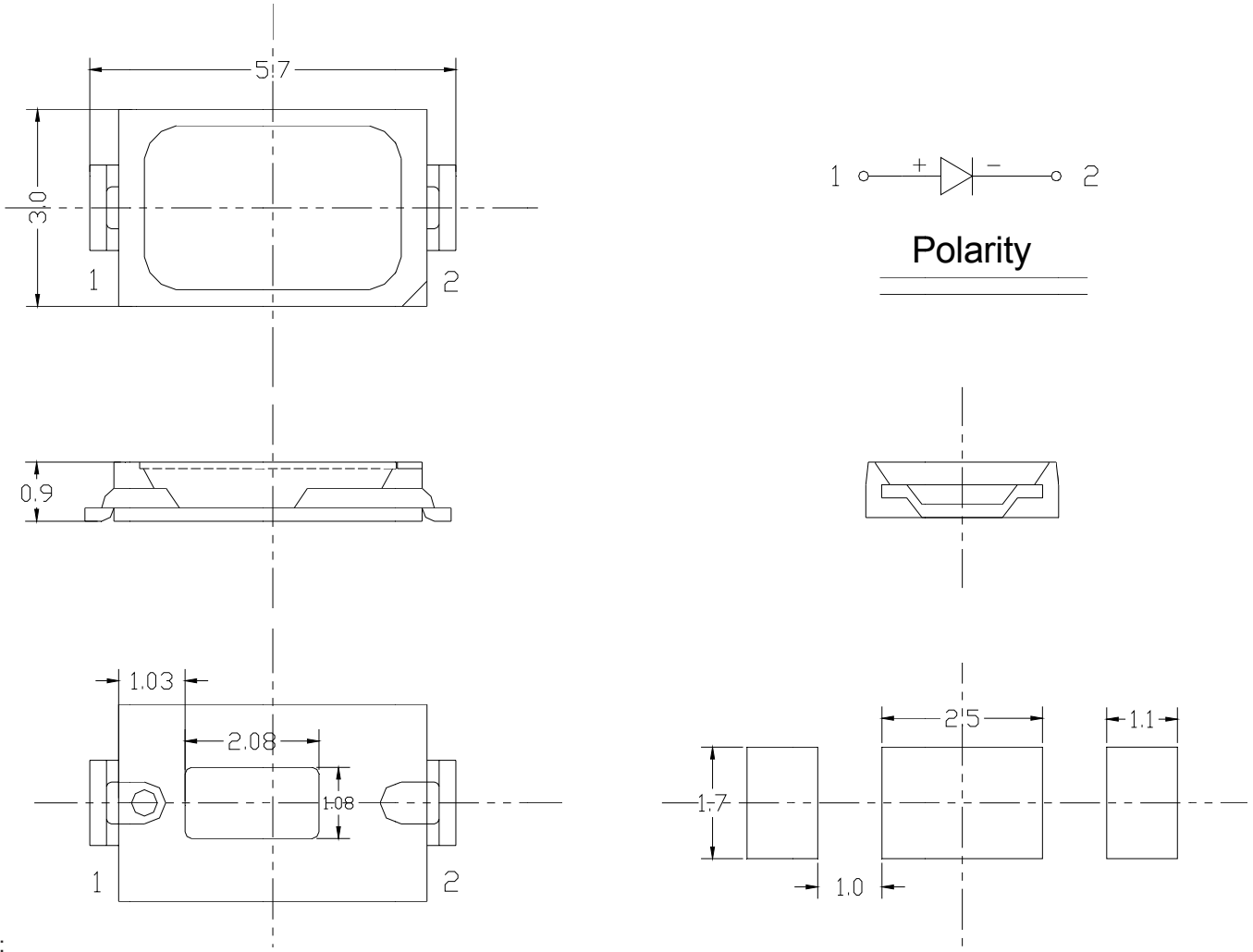

ChromeLED Corp. reserves the right to make changes at any time in order to supply the best product possible. The most current version of this document will always be available at: www.chromeled.com

ABSOLUTE MAXIMUM RATINGS
(TA=25°C)

Parameter	Symbol	Max Rating	Unit
Forward Current	IF	180	mA
Reverse Voltage	VR	5	V
Operating Temperature Range	TOP	-40~+85	°C
Storage Temperature Range	TSTG	-40~+100	°C
Peak Pulsing Current (1/10 duty f = 10KHz)	IFP	350	mA
Soldering Temperature	TSOL	Max 260°C for 5 sec Max	

OPTICAL-ELECTRICAL CHARACTERISTICS
(TA=25°C)

Parameter	Symbol	Test Condition	Value			Unit
			Min	Typ	Max	
Luminous Intensity	Iv	IF = 150mA	50	60	-	lm
Forward Voltage	VF	IF = 150mA	-	3.1	3.4	V
Reverse Leakage Current	IR	VR = 5V	-	-	10	µA
Viewing Angle at 50% Iv	2θ1/2	IF = 150mA	-	120	-	Deg
Color Rendering Index	CRI	IF = 150mA	80	82	-	-
Correlated Color Temperature	CCT	IF = 150mA	3700	-	4500	K

*Tolerance of viewing angle: -10 / +5 deg.



ChromeLED Corp. reserves the right to make changes at any time in order to supply the best product possible. The most current version of this document will always be available at: www.chromeled.com

OPTICAL CHARACTERISTIC CURVES

Fig.1-Forward Voltage Vs. Forward Current
伏安特性曲线

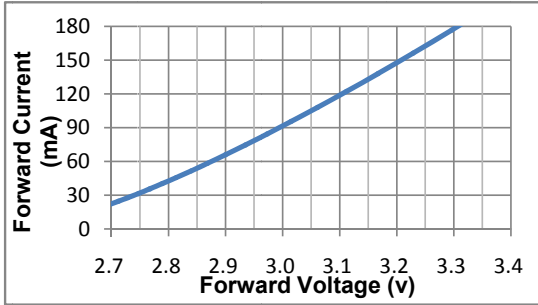

Fig.2-Forward Current Vs. Relative Intensity
正向电流与相对光强特性曲线

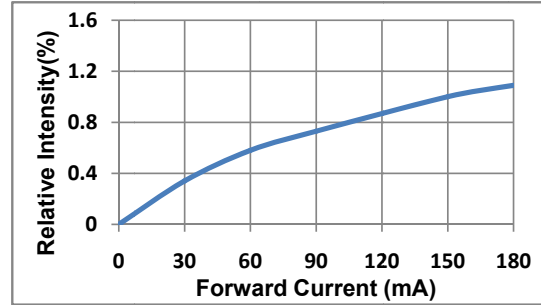

Fig.3-Ambient Temperature Vs. Relative Intensity
环境温度与相对光强特性曲线

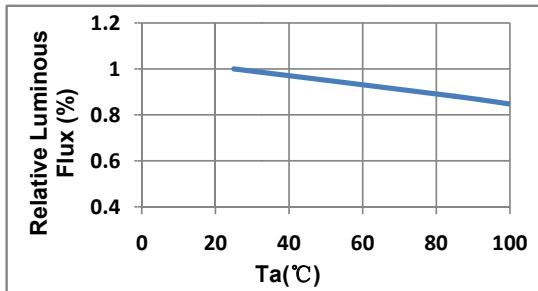

Fig.4-Ambient Temperature Vs. Forward Current
环境温度与正向电流特性曲线

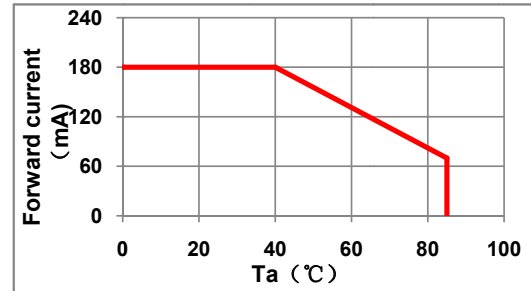

Fig.5-Forward Voltage Vs. Ambient Temperature
电压与环境温度特性曲线

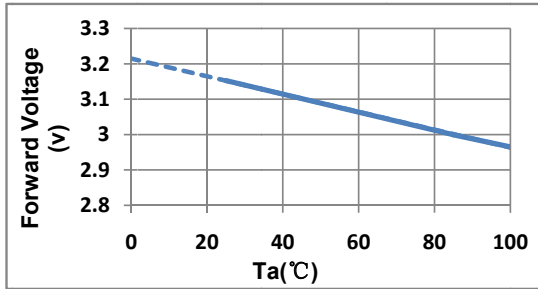

Fig.6-Radiation diagram
辐射特性曲线

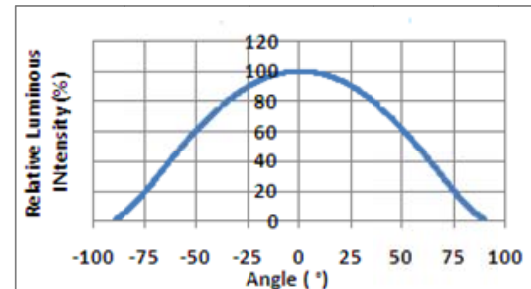

Fig.7-Chromaticity Coordinate Vs. Ambient Temperature
色坐标与环境温度特性曲线

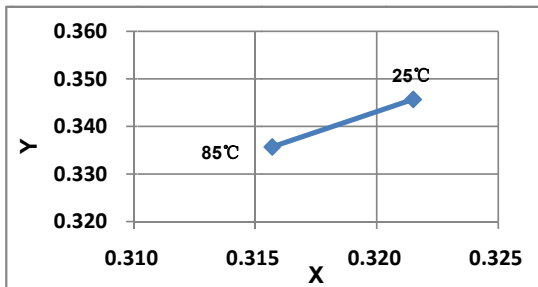
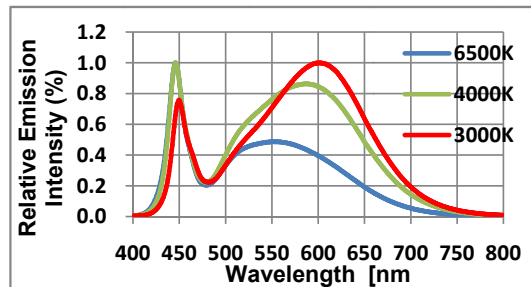
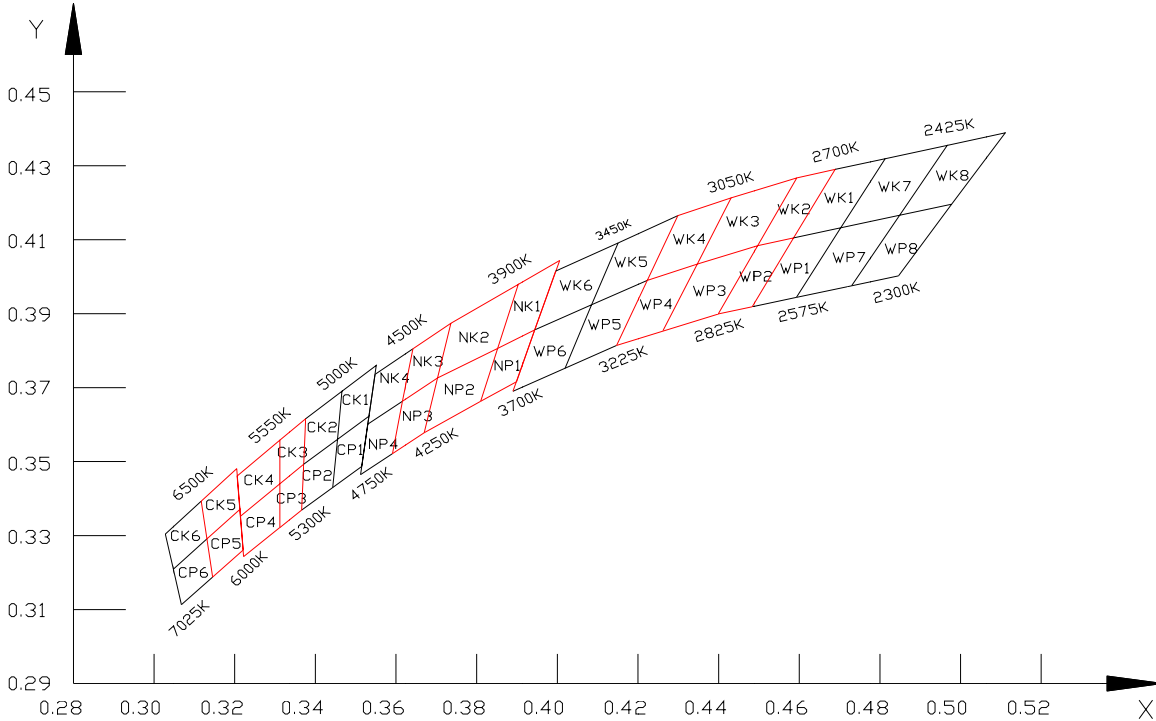

Fig.8- Spectrum Distribution
光谱分布特性曲线



ChromeLED Corp. reserves the right to make changes at any time in order to supply the best product possible. The most current version of this document will always be available at: www.chromeled.com

OPTICAL CHARACTERISTIC CURVES
The Chromaticity Diagram

Bin Data:

BIN	X1	Y1	X2	Y2	X3	Y3	X4	Y4
CP5	0.3145	0.3188	0.3131	0.3291	0.3213	0.3371	0.3221	0.3261
CK5	0.3131	0.3291	0.3117	0.3393	0.3205	0.3481	0.3213	0.3371
CP4	0.3222	0.3243	0.3214	0.3352	0.3312	0.3440	0.3312	0.3322
CK4	0.3214	0.3352	0.3206	0.3461	0.3312	0.3558	0.3312	0.3440
CP3	0.3312	0.3322	0.3312	0.3440	0.3371	0.3493	0.3366	0.3369
CK3	0.3312	0.3440	0.3312	0.3558	0.3376	0.3616	0.3371	0.3493
NP3	0.3591	0.3521	0.3616	0.3663	0.3703	0.3726	0.3670	0.3578
NK3	0.3616	0.3663	0.3642	0.3805	0.3736	0.3874	0.3703	0.3726
NP2	0.3670	0.3578	0.3703	0.3726	0.3852	0.3806	0.3810	0.3663
NK2	0.3703	0.3726	0.3736	0.3874	0.3903	0.3979	0.3852	0.3806
NP1	0.3810	0.3663	0.3852	0.3806	0.3944	0.3856	0.3899	0.3716
NK1	0.3852	0.3806	0.3903	0.3979	0.4006	0.4044	0.3944	0.3856
WP3	0.4262	0.3854	0.4347	0.4034	0.4497	0.4084	0.4399	0.3899
WK3	0.4347	0.4034	0.4431	0.4213	0.4594	0.4267	0.4497	0.4084
WP2	0.4399	0.3899	0.4497	0.4084	0.4586	0.4105	0.4483	0.3918
WK2	0.4497	0.4084	0.4594	0.4267	0.4689	0.4290	0.4586	0.4105
WP1	0.4483	0.3918	0.4586	0.4105	0.4703	0.4132	0.4593	0.3944
WK1	0.4586	0.4105	0.4689	0.4290	0.4813	0.4319	0.4703	0.4132



ChromeLED Corp. reserves the right to make changes at any time in order to supply the best product possible. The most current version of this document will always be available at: www.chromeled.com

SOLDERING CONDITIONS

SMT Reflow Soldering Instructions SMT回流焊说明

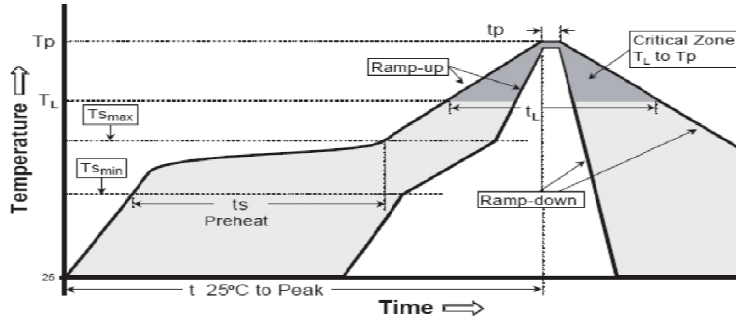

平均升温速度 (Tsmax 至 Tp)	最高 3 °C/ 秒	最高 3 °C/ 秒
预热：最低温度 (Tsmmin)	100 °C	150 °C
预热：最高温度 (Tsmax)	150 °C	200 °C
预热：时间 (tsmin 至 tsmax)	60 - 120 秒	60 - 180 秒
限时维持高温：温度 (TL)	183 °C	217 °C
限时维持高温：时间 (tl)	60 - 150 秒	60 - 150 秒
峰值 / 分类温度 (Tp)	215 °C	260 °C
与实际峰值温度 (tp) 相差 5 °C 以内的保持时间	10 - 30 秒	20 - 40 秒
降温速度	最高 6 °C/ 秒	最高 6 °C/ 秒
25 °C 升至峰值温度所需时间	最多 6 分钟	最多 8 分钟

1.Reflow soldering should not be done more than two times. In the case of more than 24 hours passed soldering after first, LEDs will be damaged. 回流焊次数不可以超过两次，两次回流焊的时间间隔如果超过24小时，LED可能由于吸湿而损坏

2.When soldering, do not put stress on the LEDs during heating当焊接时，不要在材料受热时用力压胶体表面。

■ Soldering Iron 烙铁焊接

- 1.When hand soldering, keep the temperature of iron below less 300°C less than 3 seconds
当手工焊接时，烙铁的温度必须小于300°C，时间不可超过3秒。
- 2.The hand solder should be done only one time.手工焊接只可焊接一次。

■ Repairing 修补

Repair should not be done after the LEDs have been soldered. When repairing is unavoidable,a double-head soldering iron should be used (as below figure). It should be confirmed in advance whether the characteristics of LEDs will or will not be damaged by repairing. LED回流焊后不应该修复，当必须修复时，必须使用双头烙铁，而且事先应确认此种方式会不会损坏LED本身的特性。

■ Cautions 注意事项

- 1.The encapsulated material of the LEDs is silicone. Therefore the LEDs have a soft surface on the top of package. The pressure to the top surface will be influence to the reliability of the LEDs. Precautions should be taken to avoid the strong pressure on the encapsulated part. So when use the picking up nozzle, the pressure on the silicone resin should be proper. LED封装胶为硅胶，表面较软，用力按压胶体表面会影响LED可靠性，因此应有预防措施避免在按压器件，当使用吸嘴时，胶体表面的压力应是恰当的。
2. Components should not be mounted on warped (non coplanar) portion of PCB. After soldering, do not warp the circuit board.LED灯珠不要焊接在弯曲的PCB板上，焊接之后，也不要弯折线路板。
3. Do not apply mechanical force or excess vibration during the cooling process to normal temperature after soldering. Do not rapidly cool device after soldering. 回流焊之后冷却过程中，不要对材料施加外力，也不要震动，回流焊后，不要采用激剧冷却的方式。



ChromeLED Corp. reserves the right to make changes at any time in order to supply the best product possible. The most current version of this document will always be available at: www.chromeled.com