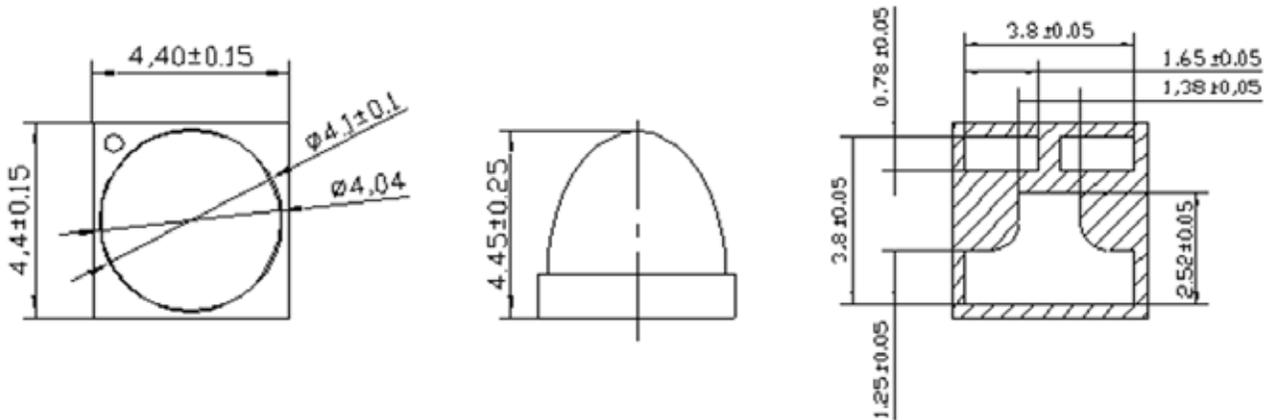
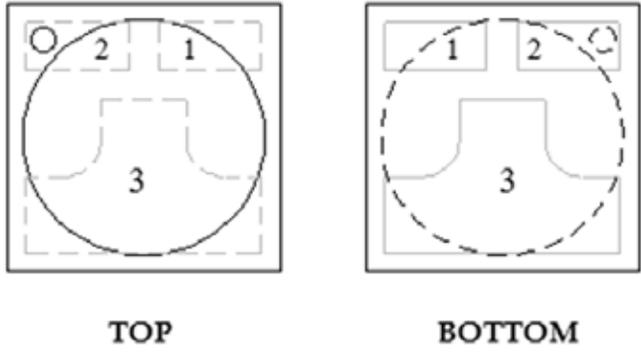

SPECIFICATIONS **CSHD1717UV385CZ-4**
MECHANICAL DIMENSIONS

PAD CONFIGURATION

Pad	Function
1	Cathode
2	Anode
3	Thermal

- Notes:
1. All dimensions are in millimeters (inches).
 2. Tolerance is $\pm 0.25\text{mm}$ (0.01") unless otherwise noted.
 3. Specifications are subject to change without notice.

Part Number	Chip Material	Color of Emission	Lens Type	Viewing Angle
CSHD1717UV385CZ-4	InGaN	UV	Water Clear	30°



ChromeLED Corp. reserves the right to make changes at any time in order to supply the best product possible. The most current version of this document will always be available at: www.chromeled.com

RECOMMENDED SOLDER PATTERN

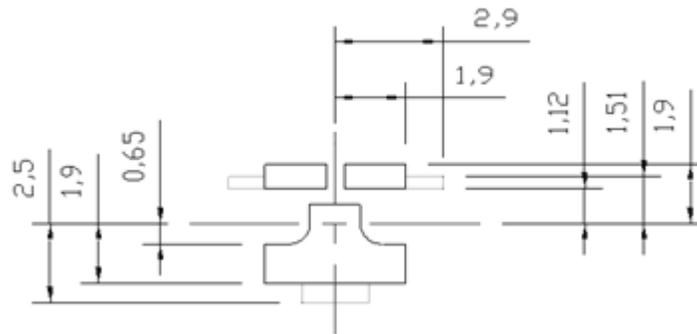
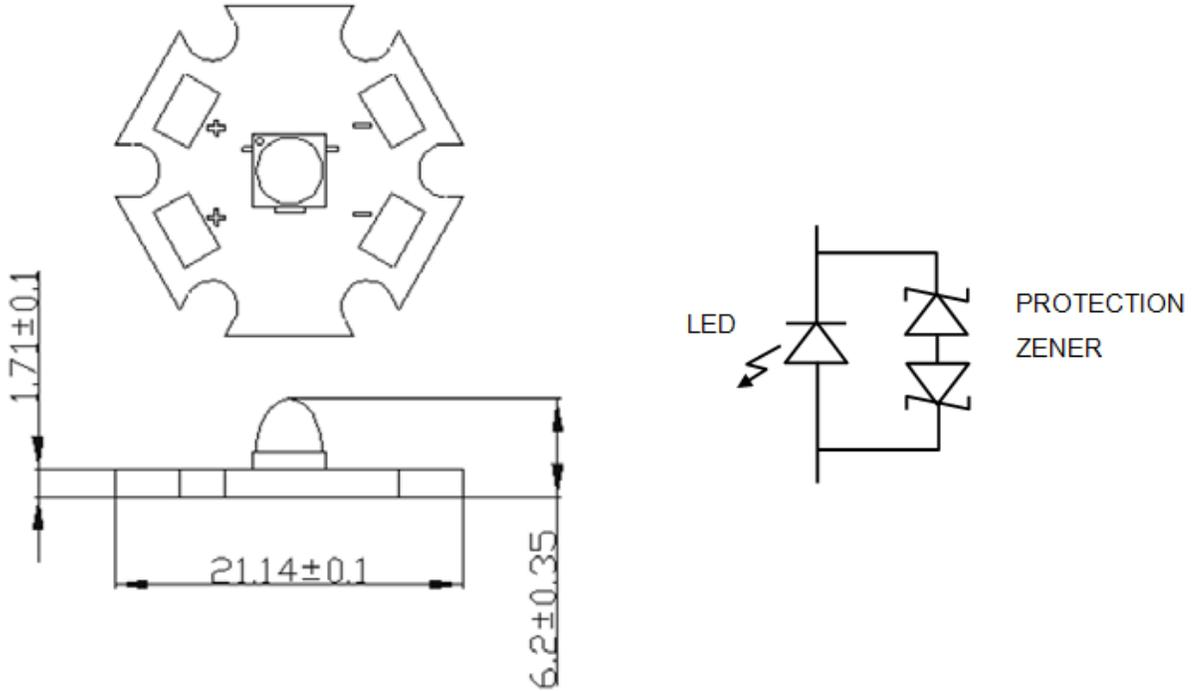

SOLDER MASK



COPPER LAYER



ChromeLED Corp. reserves the right to make changes at any time in order to supply the best product possible. The most current version of this document will always be available at: www.chromeled.com

ABSOLUTE MAXIMUM RATINGS
(TA=25°C)

Parameter	Symbol	Max Rating	Unit
Power Dissipation per Dice	P _D	3	W
Continuous Forward Current per Dice	I _F	700	mA
Peak Current per Dice (duty cycle 1/10, 1kHz)	I _{PF}	1000	mA
Thermal Resistance, Junction-Case	R _{TH, J-C1}	5	°C/W
Operating Temperature	T _{OPR}	-40~+80	°C
Storage Temperature	T _{STG}	-40~+120	°C

OPTICAL-ELECTRICAL CHARACTERISTICS
(TA=25°C)

Characteristic	Symbol	Condition	Value			Unit
			Min.	Type.	Max.	
Forward Voltage per Dice	V _F	I _F = 700mA	-	3.9	4.47	V
Peak Wavelength per Dice	λ _P		-	385	-	nm
Radiant Flux	Φ _E		350	500	-	mW
Viewing Angle	2θ 1/2		-	30	-	Deg
Spectra Half-Width	Δλ			15	-	nm

*Tolerance of viewing angle: -10 / +5 deg.



ChromeLED Corp. reserves the right to make changes at any time in order to supply the best product possible. The most current version of this document will always be available at: www.chromeled.com

OPTICAL CHARACTERISTIC CURVES

Fig. Forward Current vs. Forward Voltage

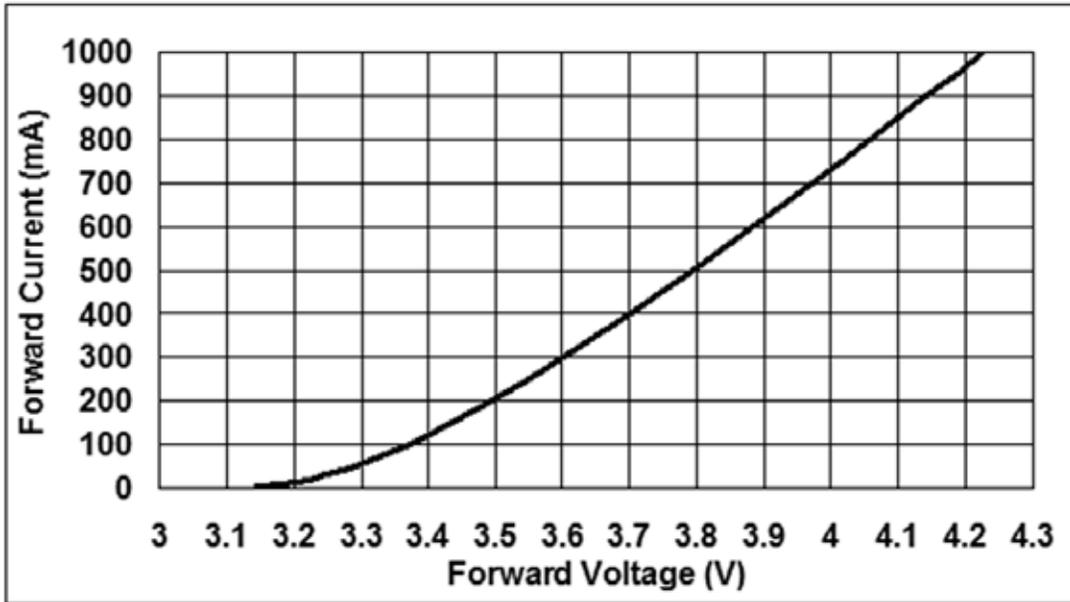
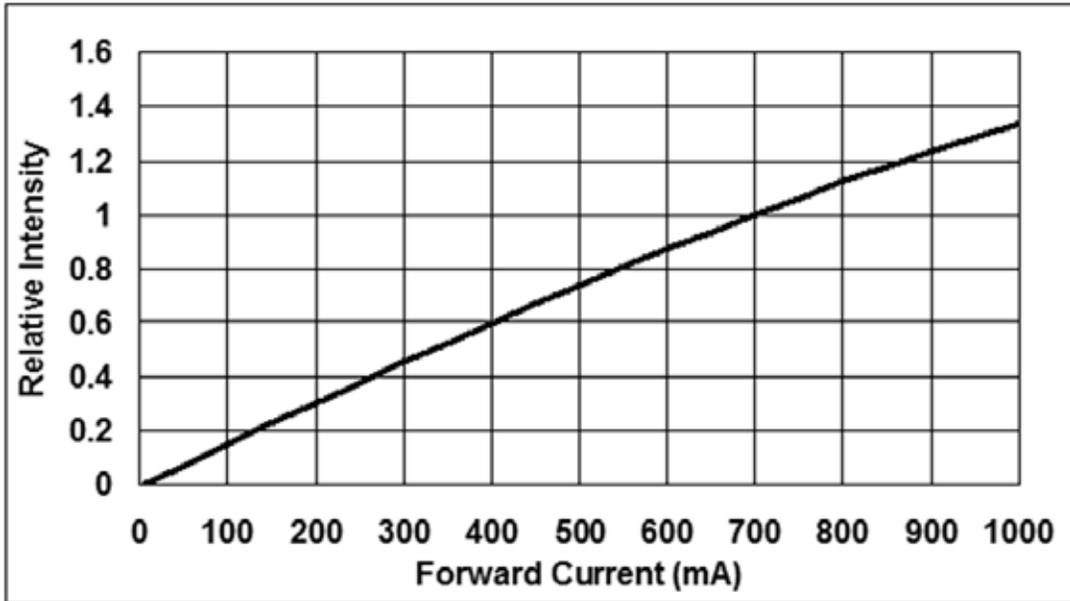

Fig. Relative Intensity vs. Forward Current



ChromeLED Corp. reserves the right to make changes at any time in order to supply the best product possible. The most current version of this document will always be available at: www.chromeled.com

OPTICAL CHARACTERISTIC CURVES

Fig. Typical Relative Intensity vs. wavelength

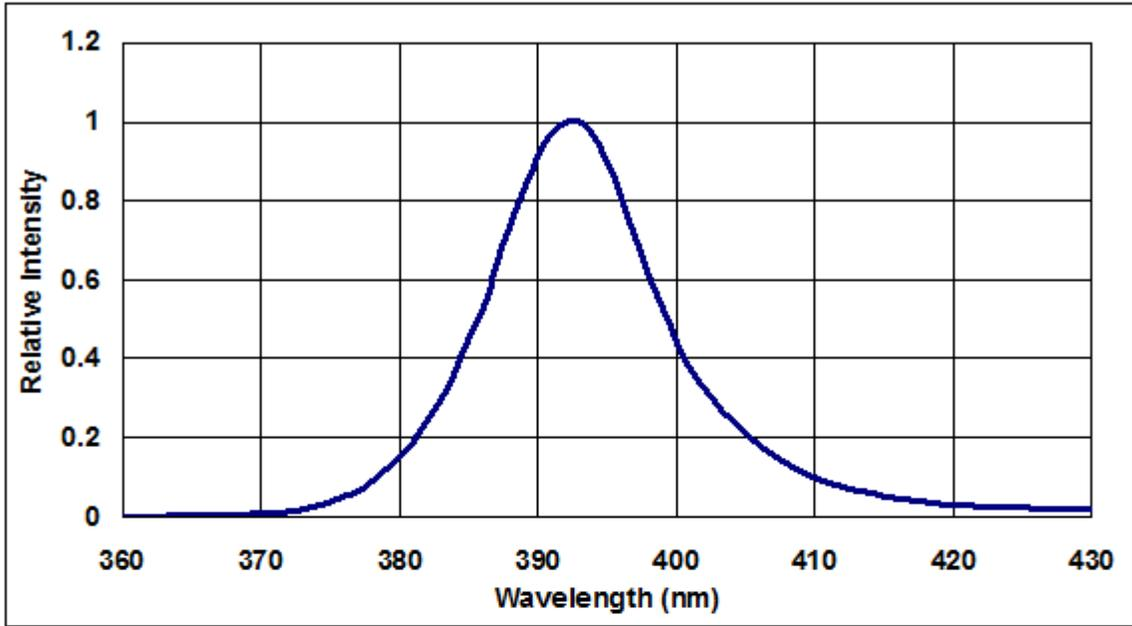
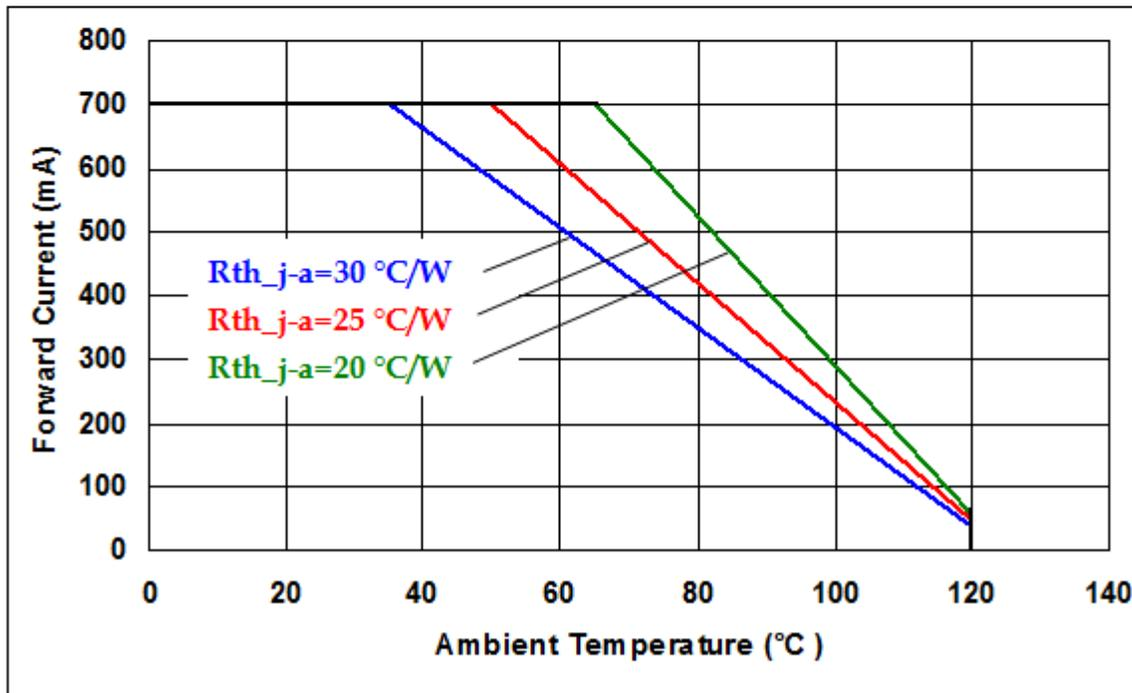

Fig. Forward Current Degrading Curve



ChromeLED Corp. reserves the right to make changes at any time in order to supply the best product possible. The most current version of this document will always be available at: www.chromeled.com

OPTICAL CHARACTERISTIC CURVES

Fig. Relative Intensity vs. Case Temperature

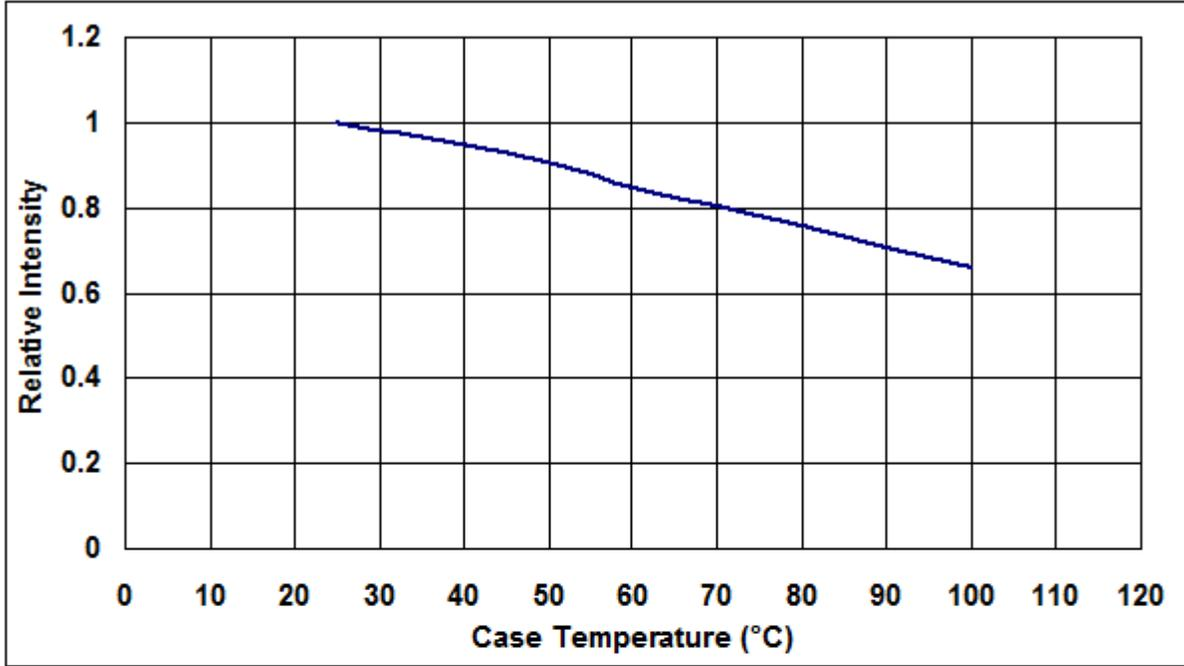
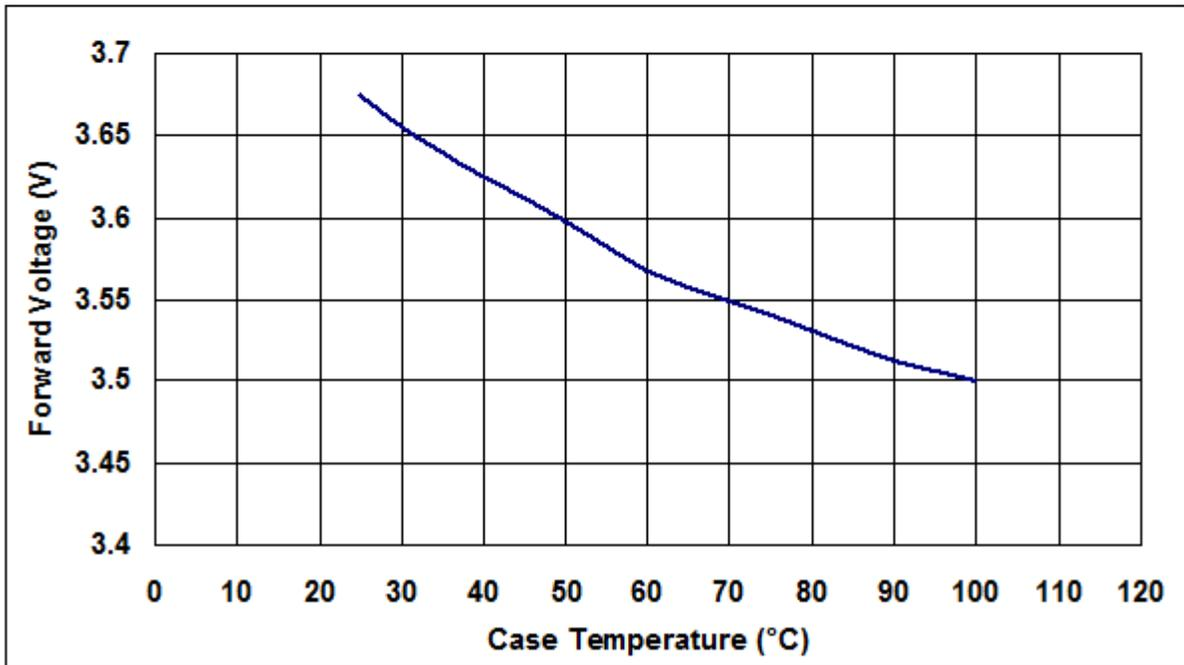

Fig. Forward Voltage vs. Case Temperature



ChromeLED Corp. reserves the right to make changes at any time in order to supply the best product possible. The most current version of this document will always be available at: www.chromeled.com

OPTICAL CHARACTERISTIC CURVES

Fig. Peak Wavelength shift vs. Case Temperature

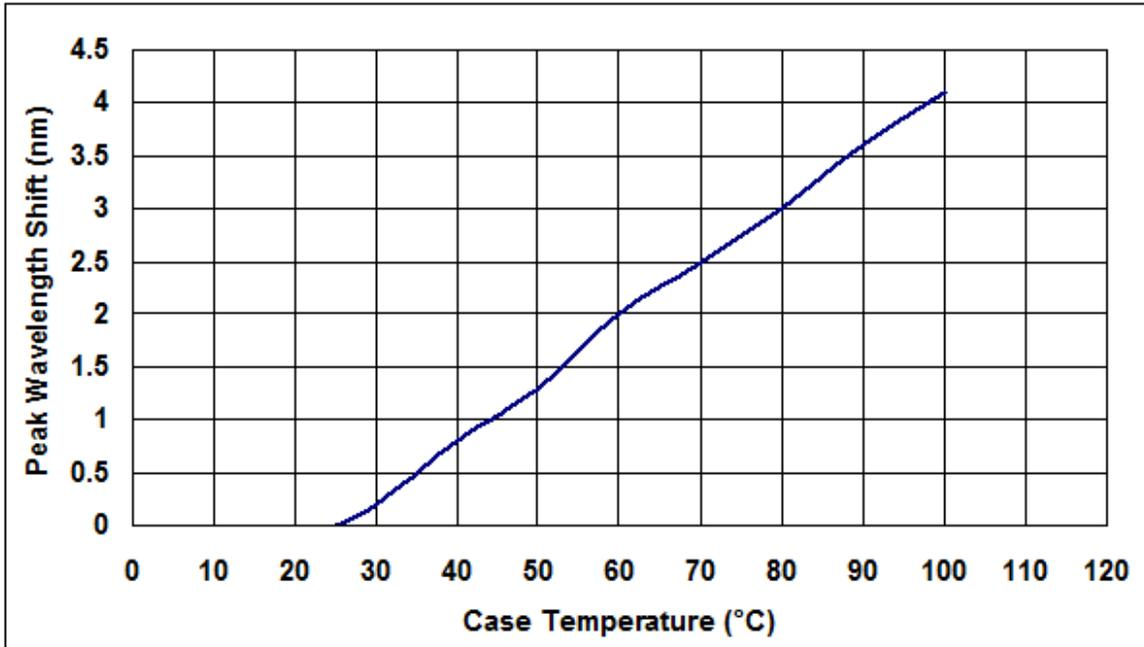
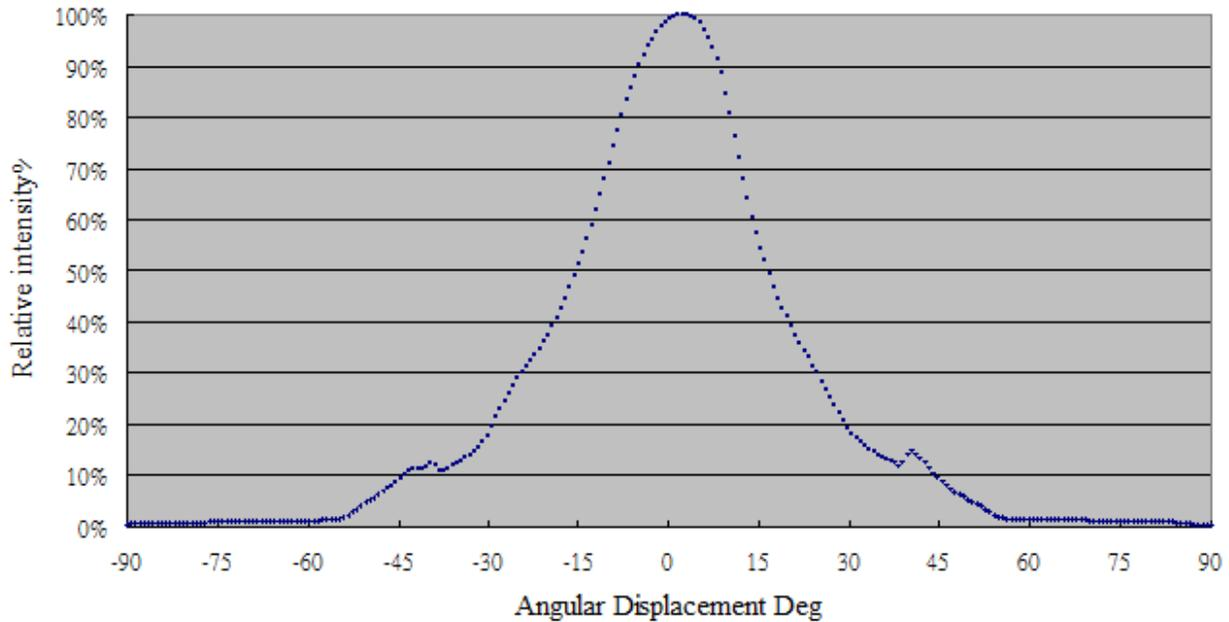

Fig. (30° Lens) Typical Representative Spatial Radiation Pattern

Typical Spatial Radiation Pattern



ChromeLED Corp. reserves the right to make changes at any time in order to supply the best product possible. The most current version of this document will always be available at: www.chromeled.com

REFLOW SOLDERING CHARACTERISTICS

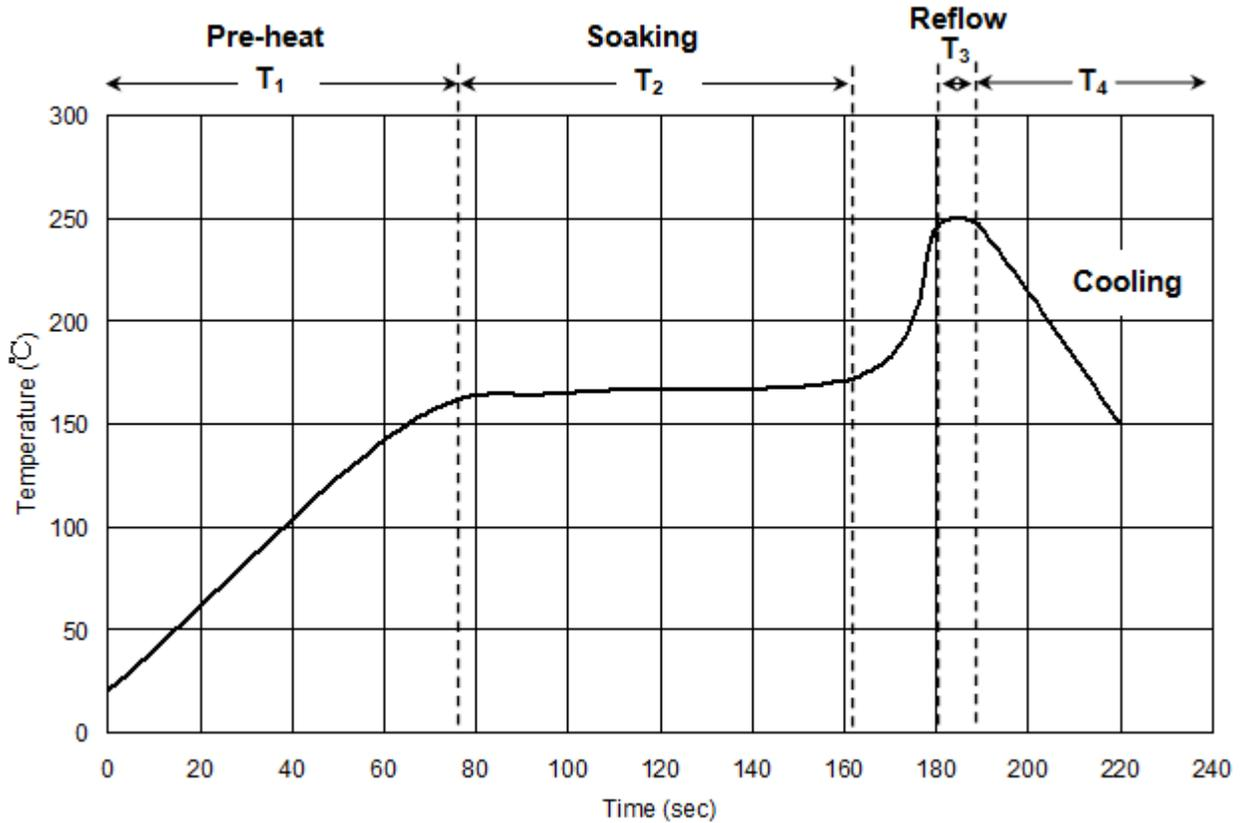

T1	Ramp up rate	1.0~3.0 °C/sec
	Pre-heat time	50~80 sec
T2	Soaking temperature	155~185 °C
	Dwell time during soaking	60~120 sec
T3	Reflow temperature	240~250 °C
	Reflow time	Max 10 sec
T4	Ramp up rate during reflow	1.2~2.3 °C/sec
	Cooling	1.0~6.0 °C.sec

Note: suggest using Sn96Ag3Cu0.5 lead free solder



ChromeLED Corp. reserves the right to make changes at any time in order to supply the best product possible. The most current version of this document will always be available at: www.chromeled.com

PACKAGE DIMENSIONS (Unit: mm)

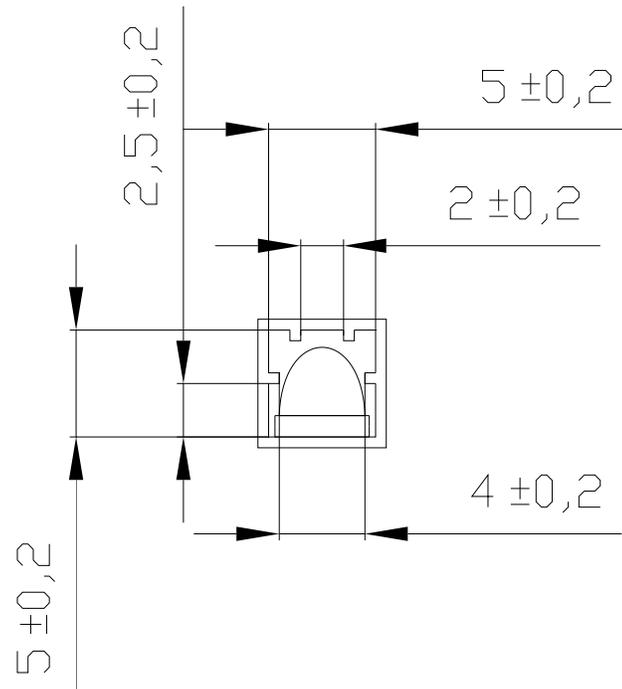

Lens Type

30 Degree Lens Type:

- 1 Tube
- 1000 Max/Tube
- 950 Tube (Max)/Box



ChromeLED Corp. reserves the right to make changes at any time in order to supply the best product possible. The most current version of this document will always be available at: www.chromeled.com