

SPECIFICATIONS CSH3537A2C

PACKAGE OUTLINES

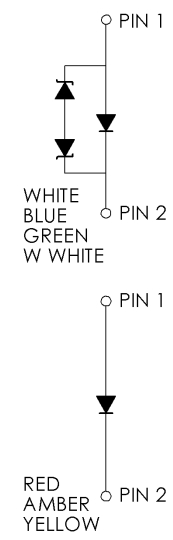
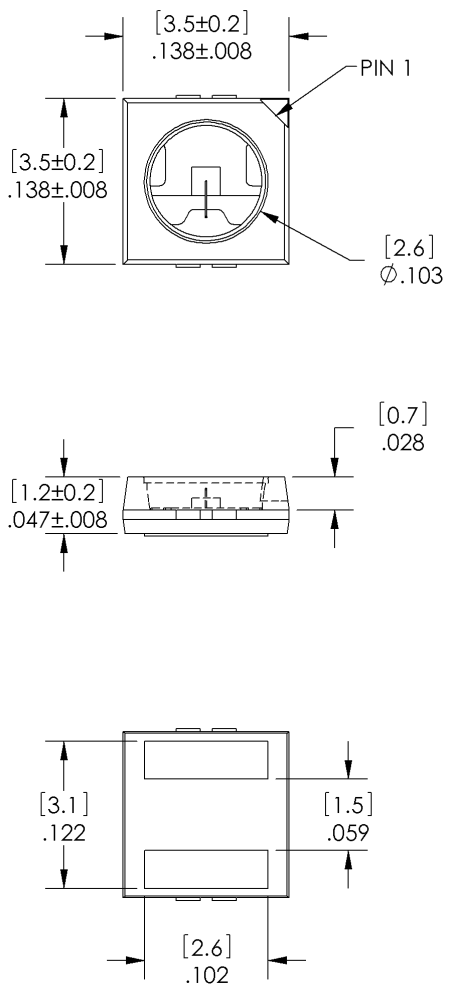

PIN 1	ANODE
PIN 2	CATHODE

- Notes:
1. All dimensions are in millimeter (inches).
 2. Tolerance is ± 0.25 mm (0.01 ") unless otherwise noted.
 3. Specifications are subject to change without notice.

Part Number	Chip Material	Color of Emission	Lens Type	Viewing Angle
CSH3537A2C	InGaAlP	Amber	Water Clear	120°



ChromeLED Corp. reserves the right to make changes at any time in order to supply the best product possible. The most current version of this document will always be available at: www.chromeled.com

ABSOLUTE MAXIMUM RATINGS
(TA=25°C)

Parameter	Symbol	Max Rating	Unit
Forward Current	I _F	200	mA
ESD Threshold (HBM)	V	2000	v
Reverse Voltage	V	12	v
Junction Temperature	T _J	125	°C
Operating Temperature Range	T _{OP}	-40~+110	°C
Storage Temperature Range	T _{STG}	-40~+110	°C
Peak Pulsing Current (1/10 duty f = 10KHz)	I _{FP}	1000	mA
Soldering Temperature	T _{SOL}	Max 260°C for 5 sec Max	

OPTICAL-ELECTRICAL CHARACTERISTICS
(TA=25°C)

Parameter	Symbol	Test Condition	Value			Unit
			Min	Typ	Max	
Peak Wavelength	λ _P	I _F = 140mA	-	621	-	nm
Dominant Wavelength	λ _D	I _F = 140mA	-	615	-	nm
Reverse Leakage Current	I _R	V _R = 5V	-	-	10	μA
Forward Voltage	V _F	I _F = 140mA	-	2.2	2.65	V
Luminous Intensity	I _v	I _F = 140mA	4500	7150	-	mcd
Luminous Intensity	I _v	I _F = 140mA	-	18.6	-	lm

*Tolerance of viewing angle: -10 / +5 deg.

 ChromeLED Corp. reserves the right to make changes at any time in order to supply the best product possible. The most current version of this document will always be available at: www.chromeled.com

RECOMMENDED SOLDER PAD

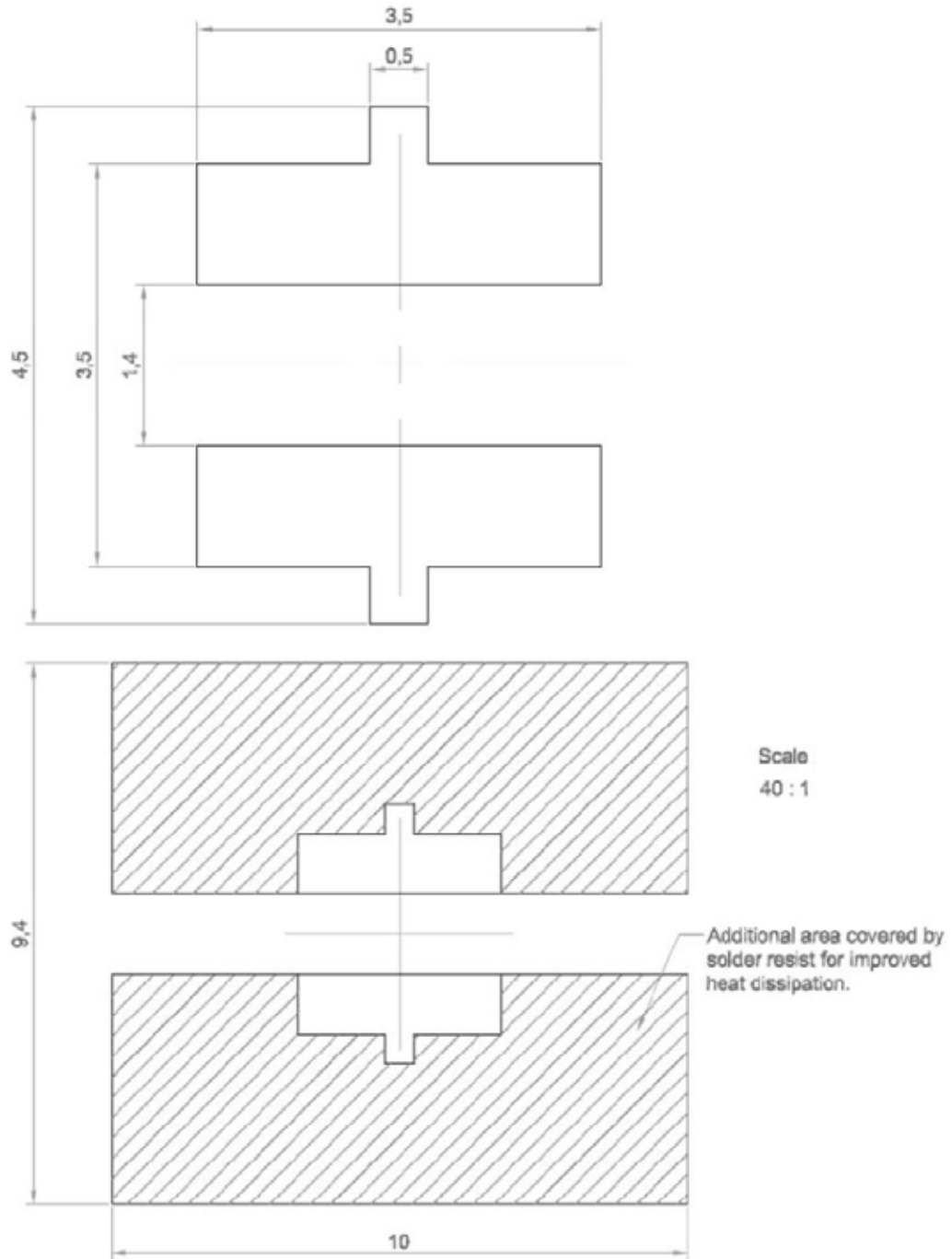

ChromeLED Corp. reserves the right to make changes at any time in order to supply the best product possible. The most current version of this document will always be available at: www.chromeled.com

OPTICAL CHARACTERISTIC CURVES

Relative Intensity Vs Forward Current

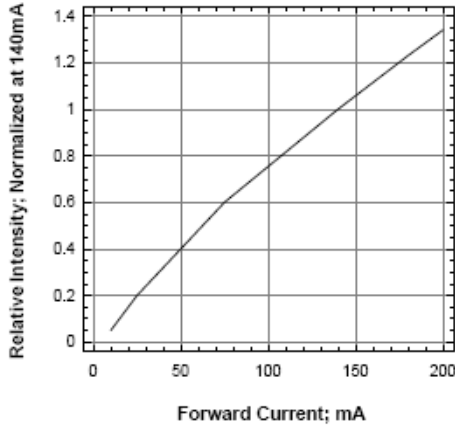

Forward Voltage Vs Forward Current

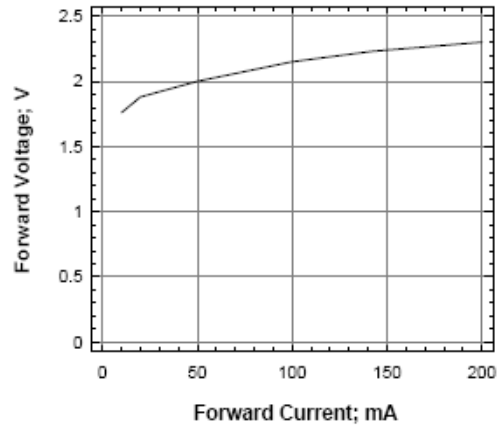

Radiation Pattern

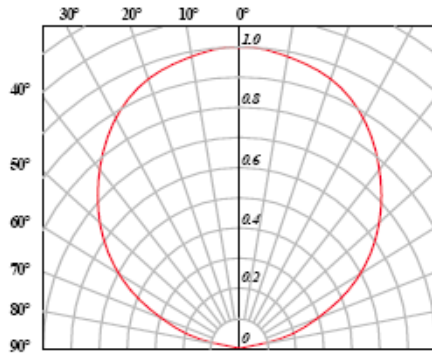

Relative Intensity Vs Wavelength

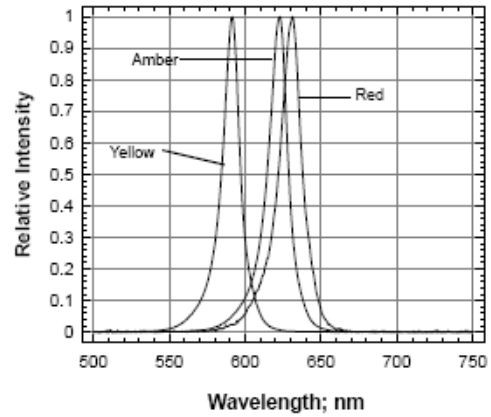

Maximum Current Vs Ambient Temperature

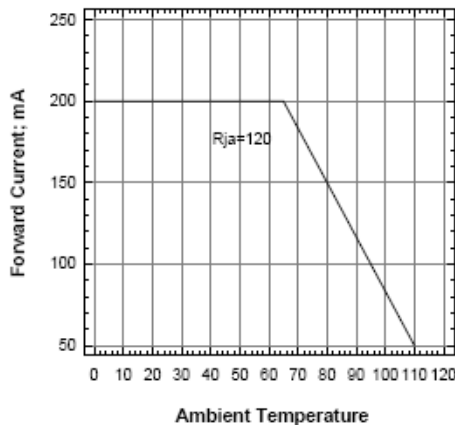

Maximum Current vs Solder-Point Temperature

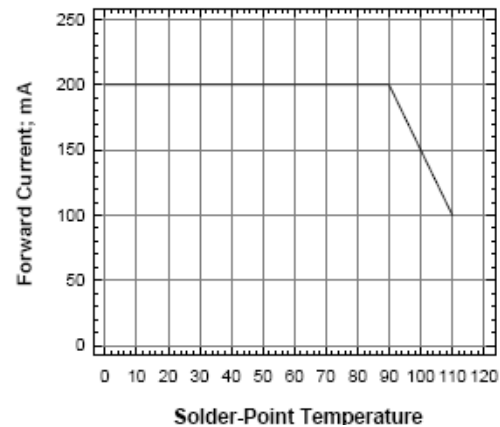

ChromeLED Corp. reserves the right to make changes at any time in order to supply the best product possible. The most current version of this document will always be available at: www.chromeled.com

SOLDERING CONDITIONS & TAPING ORIENTATION

RECOMMENDED Pb-Free Soldering Profile

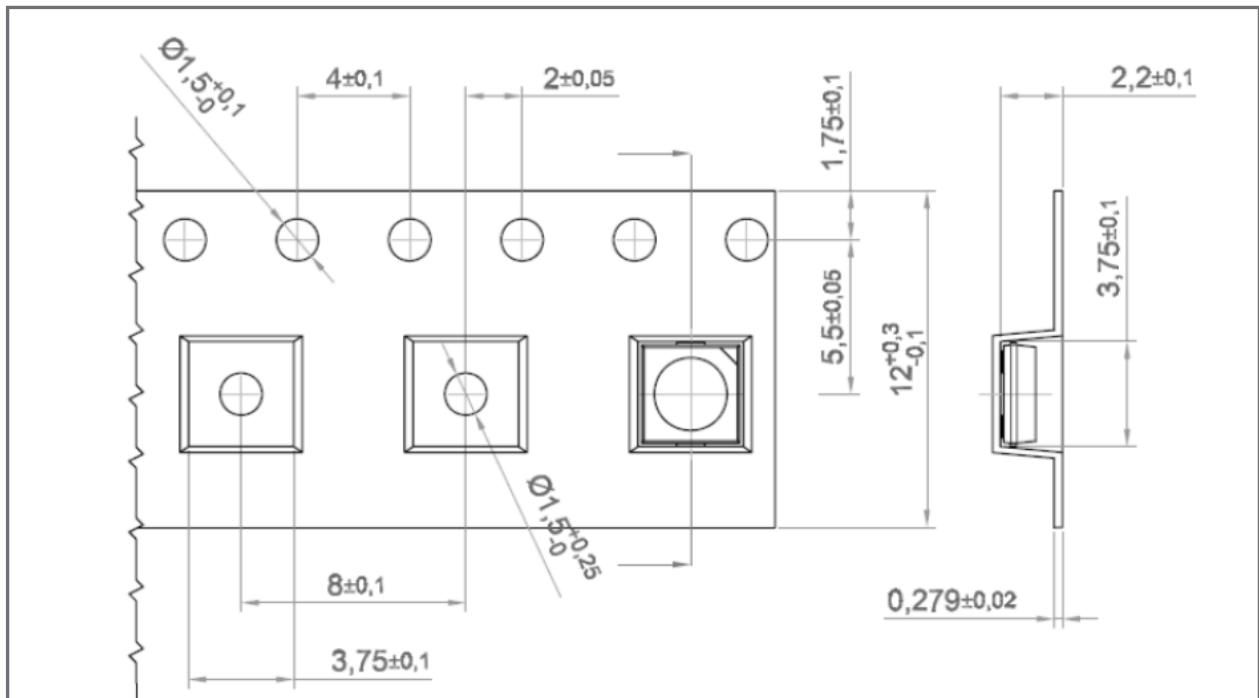
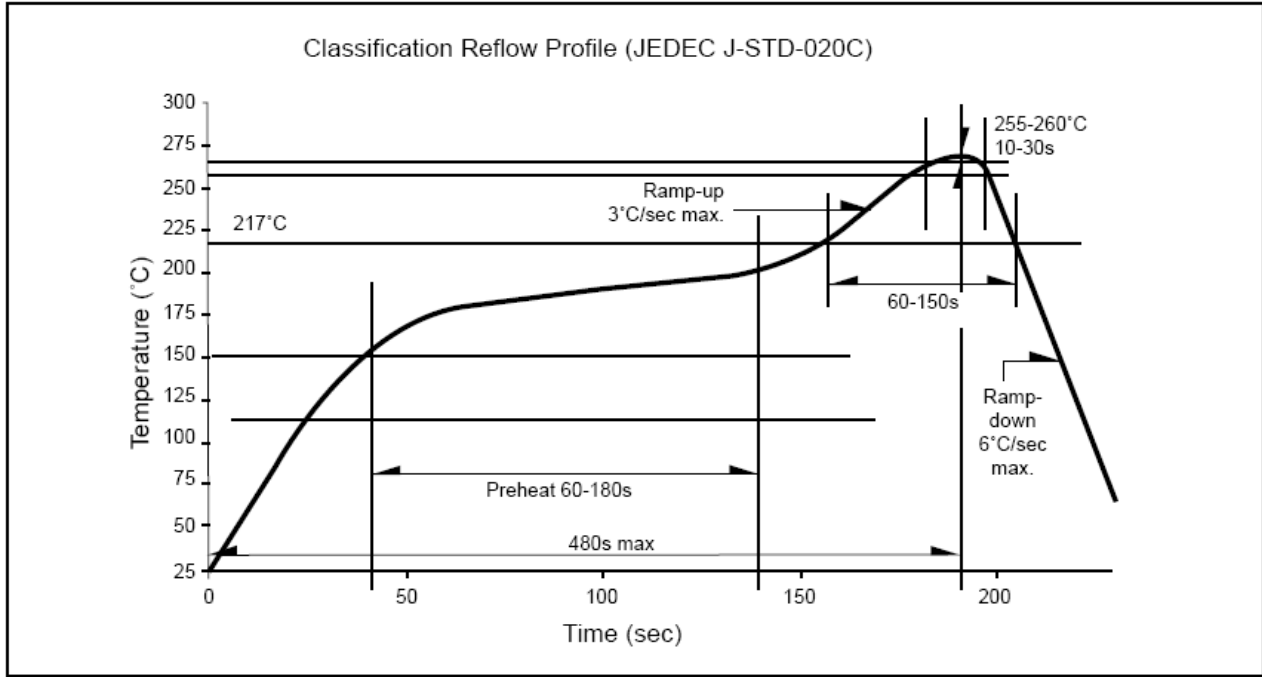

ChromeLED Corp. reserves the right to make changes at any time in order to supply the best product possible. The most current version of this document will always be available at: www.chromeled.com