

SPECIFICATIONS **CTD5959Y2WB**

OUTLINES DIMENSIONS

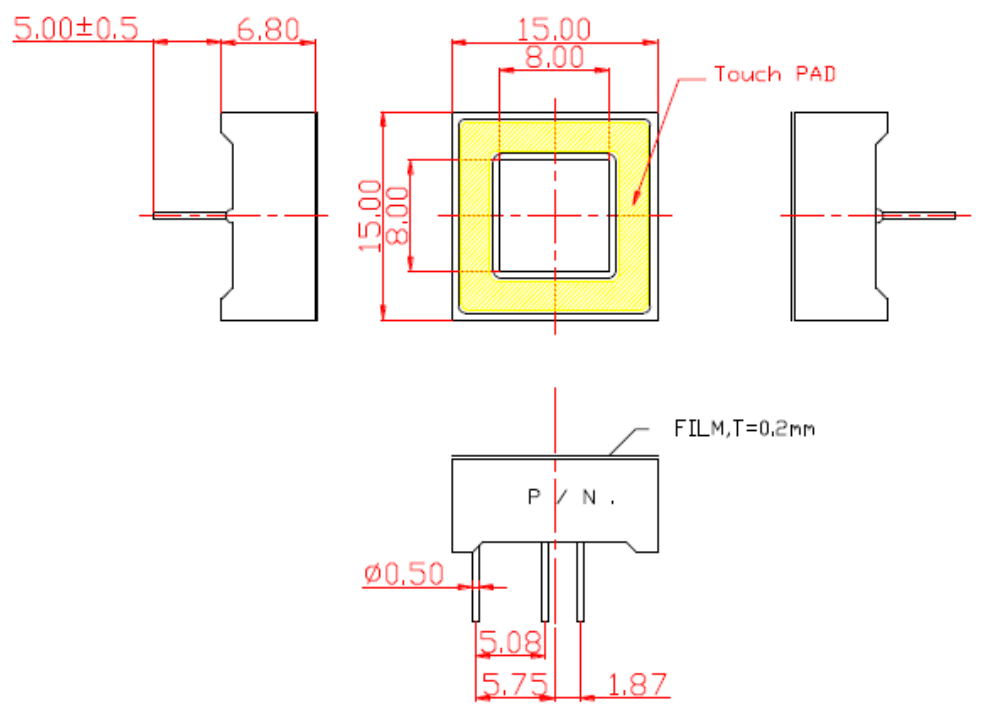

The technical drawing shows the following dimensions:

- Side view (left): Total width 5.00 ± 0.5 mm, mounting tab width 6.80 mm.
- Top view: Overall width 15.00 mm, mounting tab width 8.00 mm, central square area 8.00 mm by 8.00 mm, and a yellow shaded "Touch PAD" area.
- Bottom view: Mounting tab diameter $\phi 0.50$ mm, distance from center to tab edge 5.08 mm, distance from center to tab base 5.75 mm, and tab width 1.87 mm. Labels include "FILM, T=0,2nm" and "P / N .".

Notes:

1. All Dimensions are in millimeters (inches).
2. Tolerance is ± 0.25 mm (0.01") unless otherwise noted.
3. Specifications are subject to change without notice.

Part Number	Chip Material	Color of Emission	Lens Type	Description
CTD5959Y2WB	InGaAlP	Yellow	White	Touch Display



ChromeLED Corp. reserves the right to make changes at any time in order to supply the best product possible. The most current version of this document will always be available at: www.chromeled.com

ABSOLUTE MAXIMUM RATINGS
(TA=25°C)

Parameter	Symbol	Max Rating	Unit
Power Dissipation	PD	70	mW
Continuous Forward Current (Per Dice)	IF	25	mA
Peak Current (Per Dice)	IFP	90	mA
Reverse Voltage (Per Dice)	VR	5	V
Operating Temperature Range	TOPR	-25~+85	°C
Storage Temperature Range	TSTG	-25~+85	°C
Hand Soldering Condition: 360 °C/ 3sec			

OPTICAL-ELECTRICAL CHARACTERISTICS
(TA=25°C)

Parameter	Symbol	Test Condition	Value			Unit
			Min	Typ	Max	
Luminous Intensity	IV	IF = 20mA	-	50	-	mcd
Forward Voltage	VF	IF = 20mA	-	2.0	2.6	V
Reverse Leakage Current	IR	VR = 5V	-	-	10	µA
Peak Wavelength	λP	IF = 20mA	-	593	-	nm
Dominant Wavelength	λD	IF = 20mA	-	590	-	nm
Spectral Radiation Bandwidth	Δλ	IF = 20mA	-	20	-	nm



ChromeLED Corp. reserves the right to make changes at any time in order to supply the best product possible. The most current version of this document will always be available at: www.chromeled.com

INTERNAL CIRCUIT DIAGRAMS

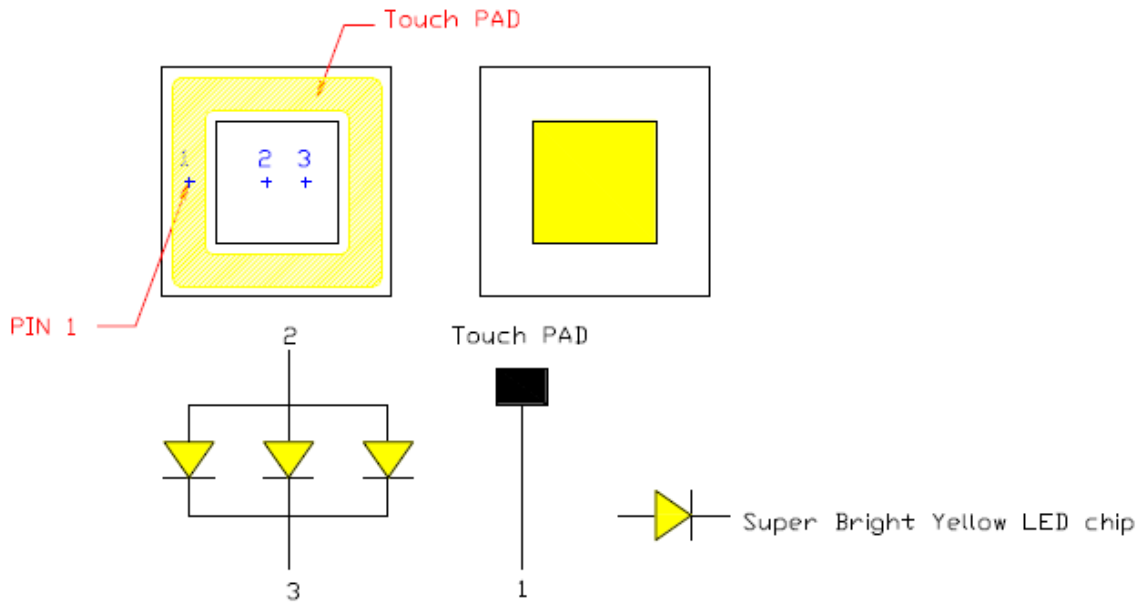

ChromeLED Corp. reserves the right to make changes at any time in order to supply the best product possible. The most current version of this document will always be available at: www.chromeled.com

TYPICAL APPLICATION CIRCUITS

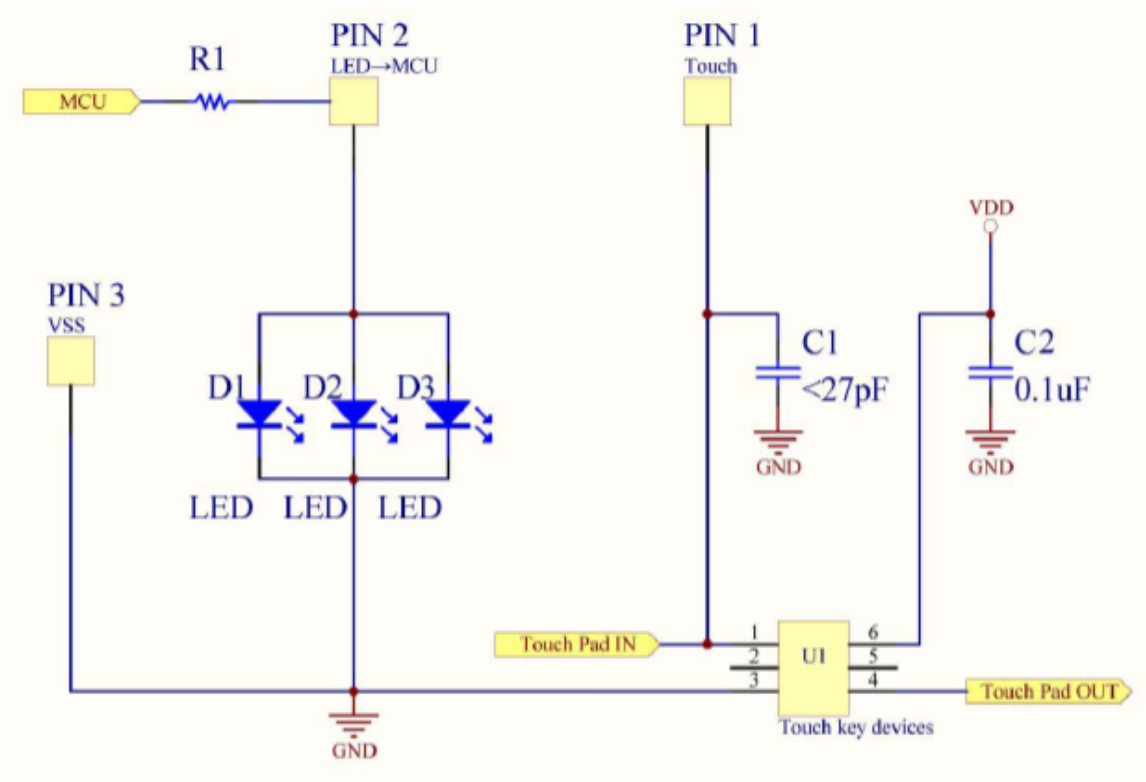

Internal Components are not customer accessible



ChromeLED Corp. reserves the right to make changes at any time in order to supply the best product possible. The most current version of this document will always be available at: www.chromeled.com

OPTICAL CHARACTERISTIC CURVES

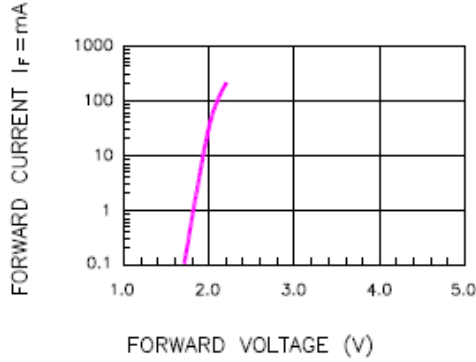

Fig.1 FORWARD CURRENT VS. FORWARD VOLTAGE

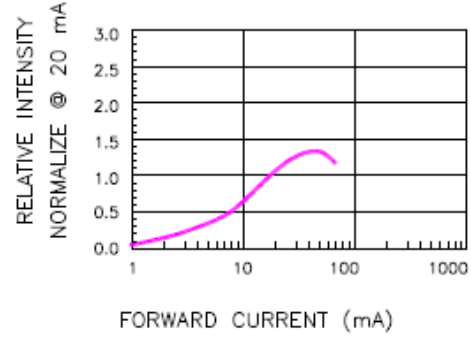

Fig.2 RELATIVE INTENSITY VS. FORWARD CURRENT

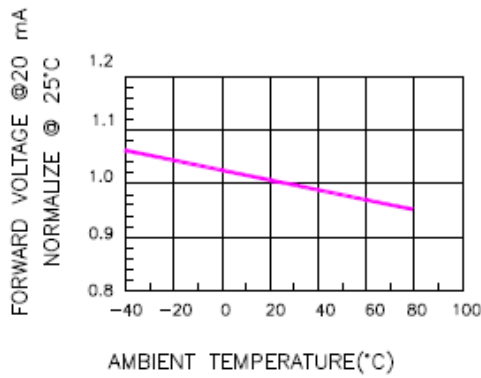

Fig.3 FORWARD VOLTAGE VS. TEMPERATURE

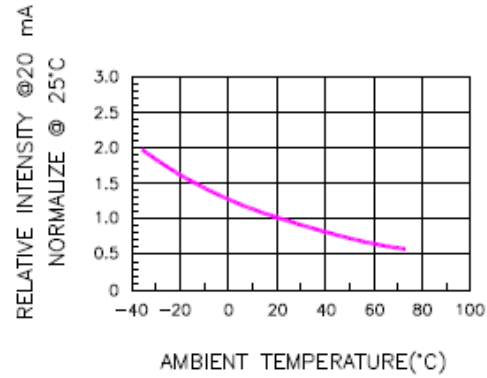

Fig.4 RELATIVE INTENSITY VS. TEMPERATURE

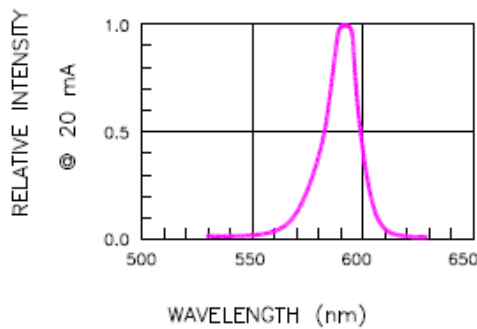

Fig.5 RELATIVE INTENSITY VS. WAVELENGTH

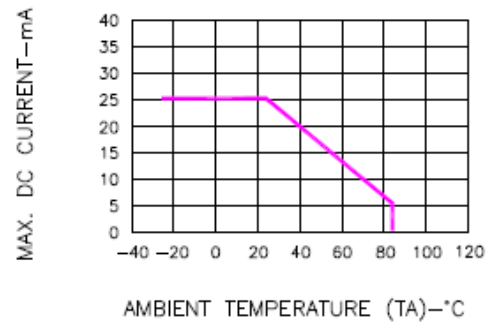
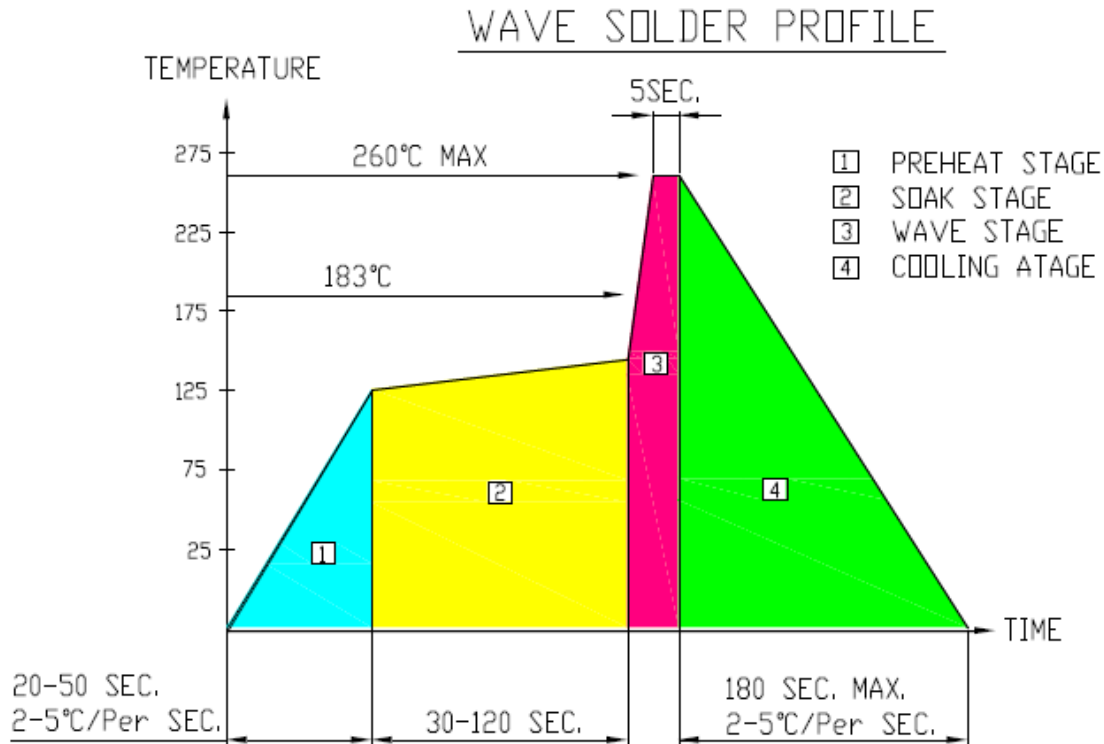

Fig.6 MAX. ALLOWABLE DC CURRENT VS. AMBIENT TEMPERATURE



ChromeLED Corp. reserves the right to make changes at any time in order to supply the best product possible. The most current version of this document will always be available at: www.chromeled.com

SOLDERING CHARACTERISTICS

NOTES

1. Recommend pre-heat temperature of 105°C or less (as measured with a thermocouple attached to the LED pins) prior to immersion in the solder wave with a maximum solder bath temperature of 260°C
2. Peak wave soldering temperature between 245°C ~ 225°C for 3 sec (5 sec max)
3. No more than one wave soldering pass

SOLDERING IRON

- Basic spec is ≤ 4 sec when 260°C. If temperature is higher, time should be shorter (+10°C → 1 sec). Power dissipation of Iron should be smaller than 15W, and temperature should be controllable. Surface temperature of the device should be under 230°C

REWORK

1. Customer must finish rework within 3 sec under 350°C
2. The head of soldering iron cannot touch copper foil



ChromeLED Corp. reserves the right to make changes at any time in order to supply the best product possible. The most current version of this document will always be available at: www.chromeled.com