

SPECIFICATIONS **SDQA56GT2W**
MECHANICAL DIMENSIONS

- Notes:
1. All dimensions are in millimeters (inches).
 2. Tolerance is $\pm 0.25\text{mm}$ (0.01") unless otherwise noted.
 3. Specifications are subject to change without notice.

Part Number	Chip Material	Color of Emission	Lens Type	Description
SDQA56GT2W	InGaN	Green	White Segment	Common Anode

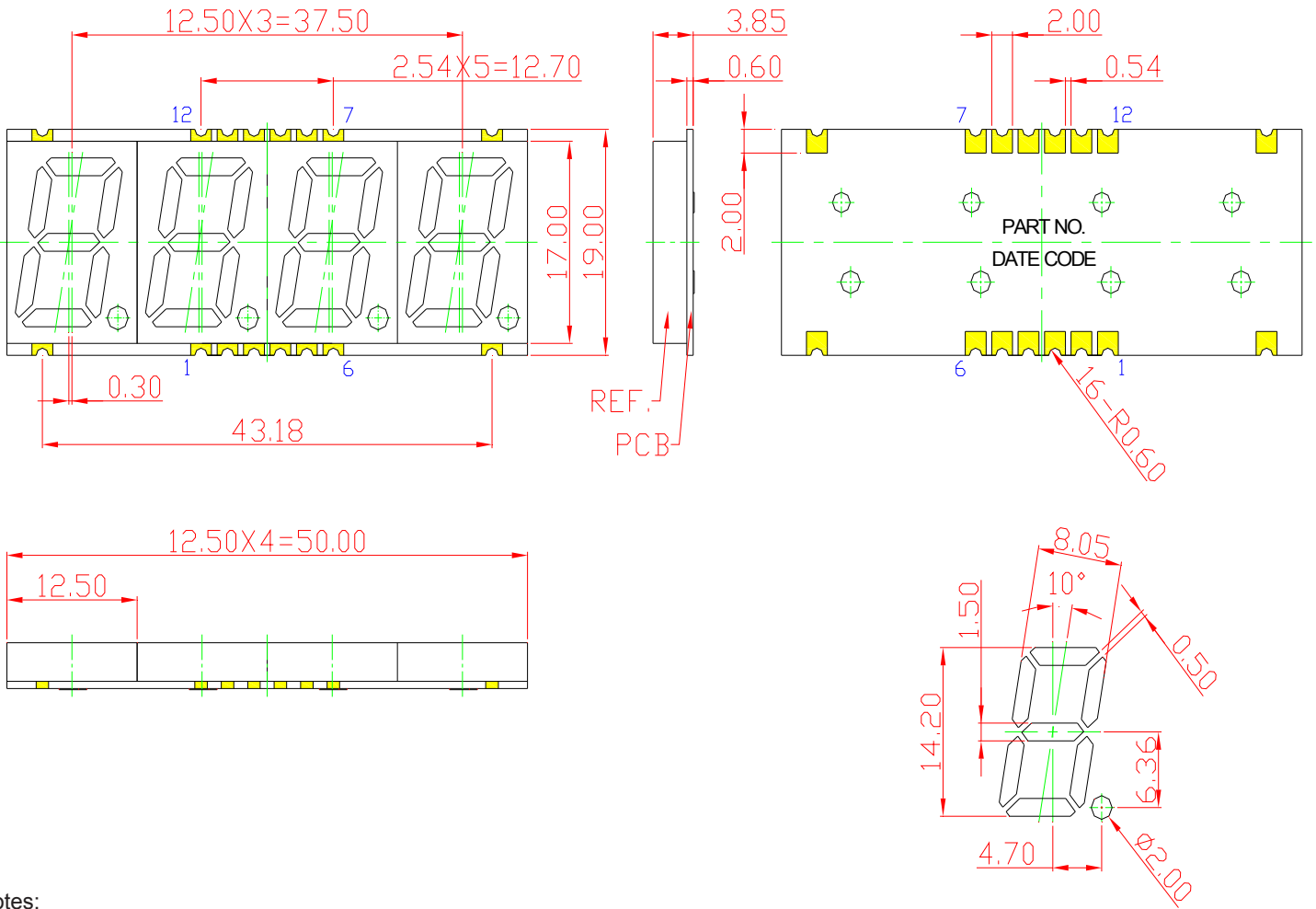

ChromeLED Corp. reserves the right to make changes at any time in order to supply the best product possible. The most current version of this document will always be available at: www.chromeled.com

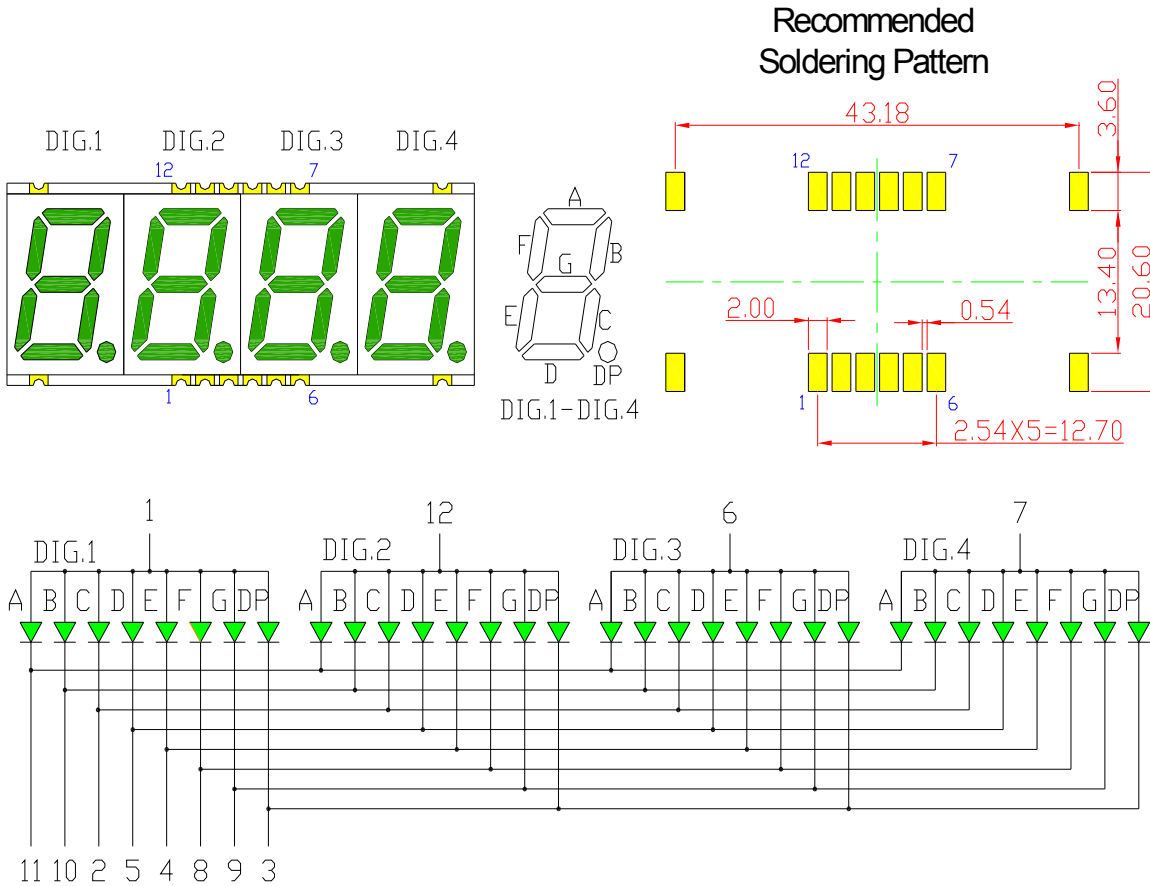
SPECIFICATIONS
TYPICAL INTERNAL EQUIVALENT CIRCUIT

Notes:

1. All dimensions are in millimeters (inches).
2. Tolerance is $\pm 0.25\text{mm}$ (0.01") unless otherwise noted.
3. Specifications are subject to change without notice.



ChromeLED Corp. reserves the right to make changes at any time in order to supply the best product possible. The most current version of this document will always be available at: www.chromeled.com

ABSOLUTE MAXIMUM RATINGS
(TA=25°C)

Parameter	Symbol		Unit
Power Dissipation per Dice	PAD	120	mW
Derating Liner from 25°C per Dice	-	0.3	mA / °C
Continuous Forward Current per Dice	IAF	30	mA
Peak Current per Dice (duty cycle 1/10, 1kHz)	IPF	100	mA
Reverse Voltage per Dice	VR	5	°C
Operating Temperature	TOPR	-40~+105	°C
Storage Temperature	TSTG	-40~+105	°C

OPTICAL-ELECTRICAL CHARACTERISTICS
(TA=25°C)

Characteristic	Symbol	Condition	Value			Unit
			Min.	Type.	Max.	
Forward Voltage per Dice	VF	IF =20mA	-	3.2	4.0	V
Reverse Current per Dice	IR	VR = 5V	-	-	10	µA
Peak Wavelength per Dice	λP	IF =20mA	-	530	-	nm
Dominant Wavelength per Dice	λD	IF =20mA	-	525	-	nm
Luminous Intensity	IV	IF =20mA	-	90	-	mcd
Spectral Radiation Bandwidth per Dice	Δλ	IF =20mA	-	30	-	nm

*Tolerance of viewing angle: -10 / +5 deg.



ChromeLED Corp. reserves the right to make changes at any time in order to supply the best product possible. The most current version of this document will always be available at: www.chromeled.com

OPTICAL CHARACTERISTIC CURVES

(25 °C Free Air Temperature Unless Otherwise Specified)

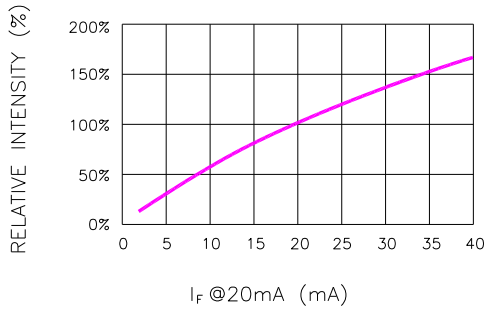

Fig.1 RELATIVE INTENSITY VS. FORWARD CURRENT

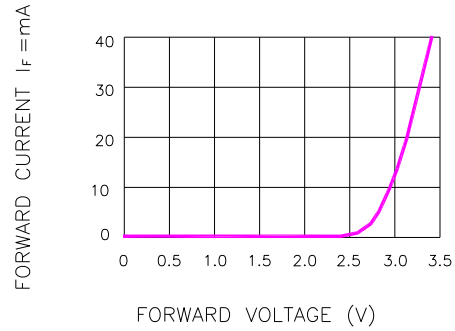

Fig.2 FORWARD CURRENT VS. FORWARD VOLTAGE

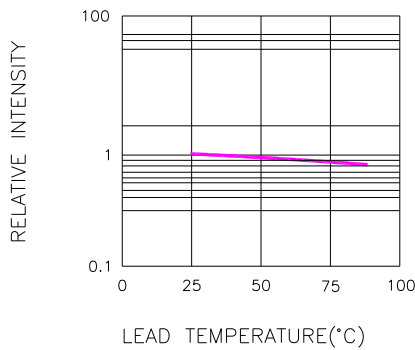

Fig.3 RELATIVE INTENSITY VS. LEAD TEMPERATURE
(PULSED 20 mA; 300us PULSE, 10ms PERIOD)

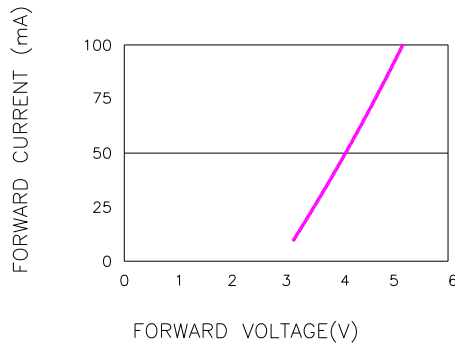

Fig.4 PEAK FORWARD VOLTAGE VS. FORWARD CURRENT (100us TEST PULSE, 1% DUTY CYCLE)

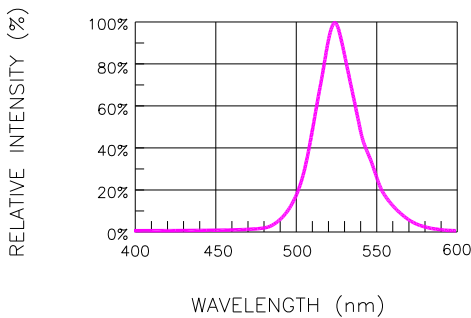

Fig.5 RELATIVE INTENSITY VS. WAVELENGTH

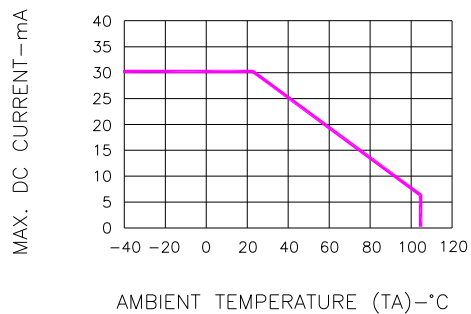

Fig.6 MAX. ALLOWABLE DC CURRENT VS. AMBIENT TEMPERATURE



ChromeLED Corp. reserves the right to make changes at any time in order to supply the best product possible. The most current version of this document will always be available at: www.chromeled.com

SOLDERING CONDITIONS – SMD TYPE LED
● RECOMMEND SOLDERING PROFILE

SMT Soldering Profile

Pb free reflow soldering Profile

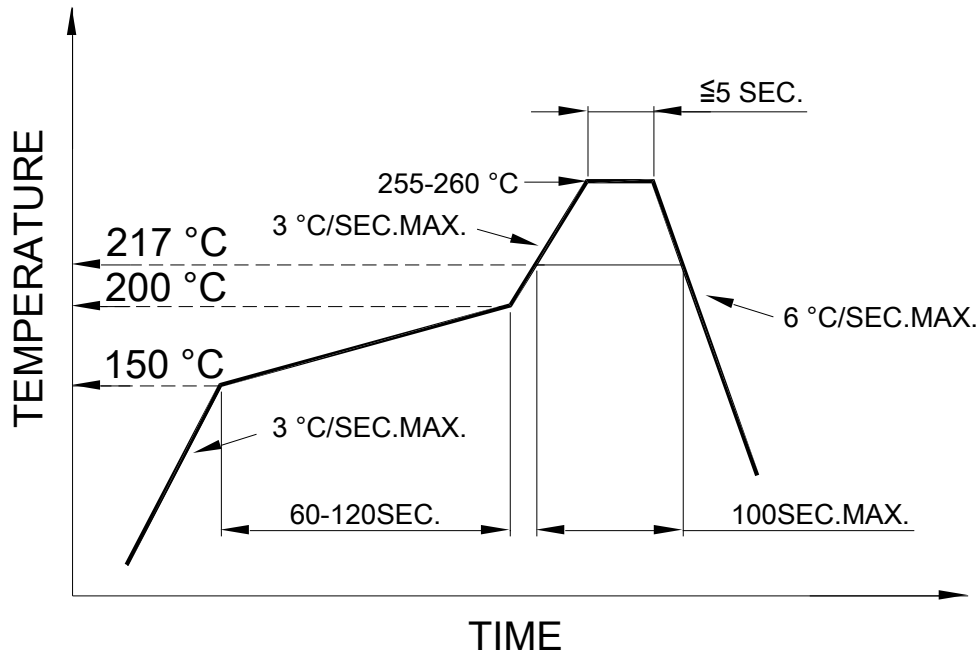
● SOLDERING IRON

Basic specification : ≤ 4 seconds when 260°C, If temperature is higher, time should be shorter (+10°C → 1 sec). Power dissipation of iron should be smaller than 15W, and temperature should be controllable. Surface temperature of the device should be under 230°C.

● REWORK

Customer must finish rework within ≤ 3 sec under 350°C.



ChromeLED Corp. reserves the right to make changes at any time in order to supply the best product possible. The most current version of this document will always be available at: www.chromeled.com

DIMENSIONS OF TAPE (Unit: mm)

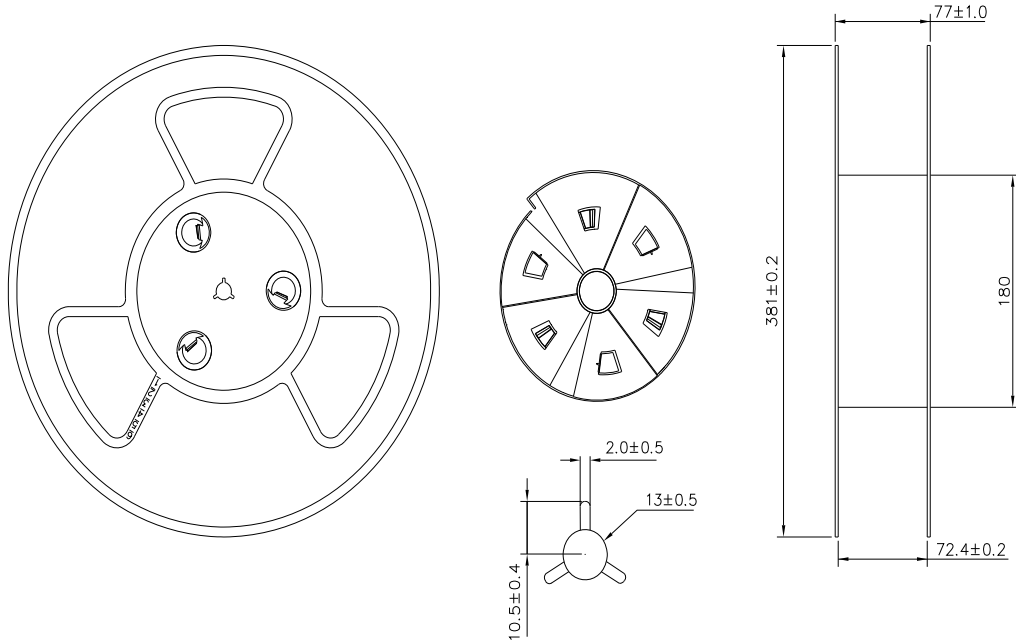

PACKAGING SPECIFICATION

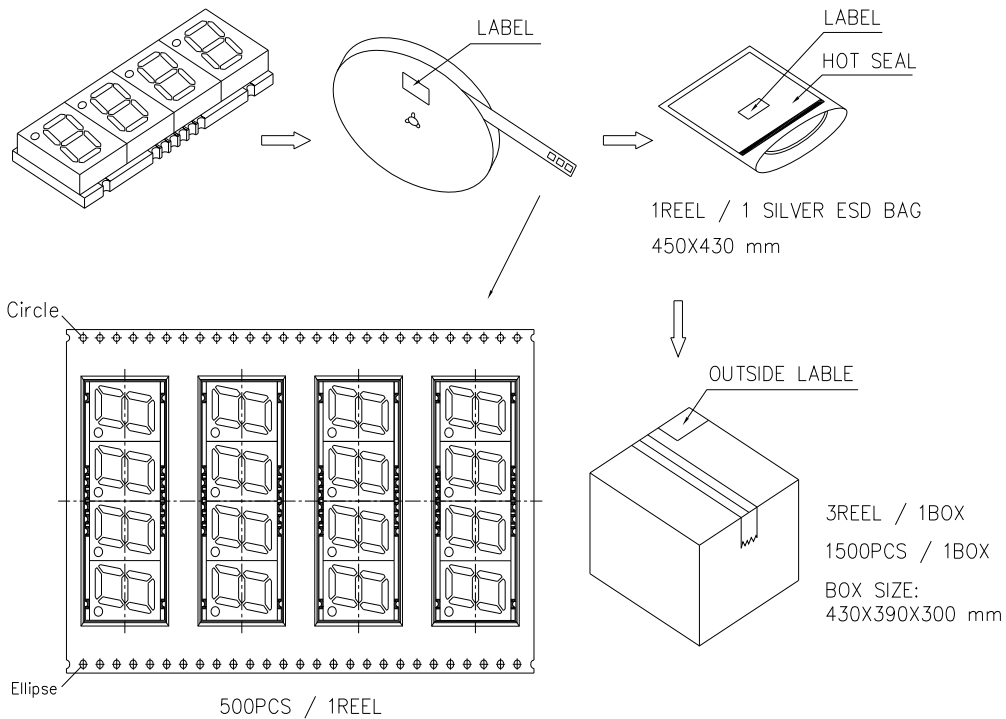

ChromeLED Corp. reserves the right to make changes at any time in order to supply the best product possible. The most current version of this document will always be available at: www.chromeled.com