

**SPECIFICATIONS** **CL50RR3C**
**OUTLINES DIMENSIONS**
**Description**

- \*Round Type
- \*T1-3/4 (5mm) Diameter
- \*Lens Color: Water Clear
- \*With Flange

**Features**

- \*Emitted Color: Red
- \*High Luminous Intensity
- \*Technology: AlGaAs
- \*Peak Wavelength = 660nm

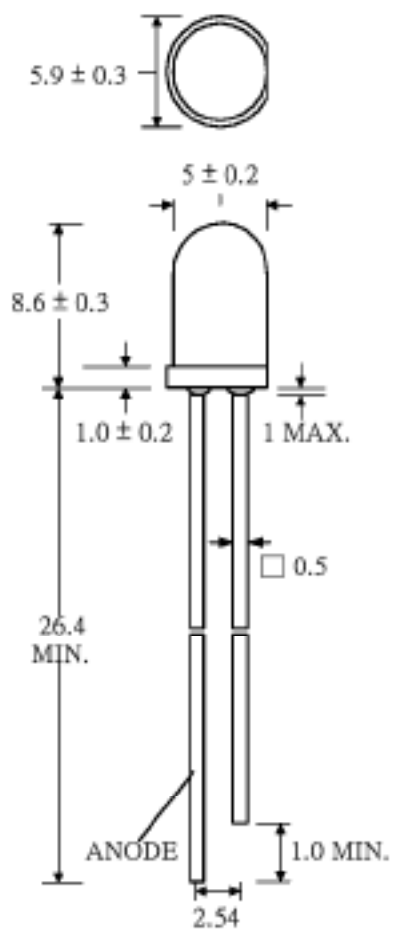

- Notes:
1. All Dimensions are in millimeters (inches).
  2. Tolerance is  $\pm 0.25\text{mm}$  (0.01") unless otherwise noted.
  3. Specifications are subject to change without notice.

Part Number	Chip Material	Color of Emission	Lens Type	Viewing Angle
CL50RR3C	AlGaAs	Red	Water Clear	30°



ChromeLED Corp. reserves the right to make changes at any time in order to supply the best product possible. The most current version of this document will always be available at: [www.chromeled.com](http://www.chromeled.com)

**ABSOLUTE MAXIMUM RATINGS**
**(TA=25°C)**

Parameter	Symbol	Max Rating	Unit
Power Dissipation	P <sub>D</sub>	80	mW
Pulse Current Forward Current	I <sub>FP</sub>	150	mA
Continuous Forward Current	I <sub>F</sub>	30	mA
Reverse Voltage	V <sub>R</sub>	5	V
Operating Temperature Range	T <sub>OPR</sub>	-40~+85	°C
Storage Temperature Range	T <sub>STG</sub>	-40~+85	°C
I <sub>FP</sub> = Pulse Width ≤ 10 ms, Duty Ratio ≤ 1/10. Soldering Condition: 260 °C/ 5sec			

**OPTICAL-ELECTRICAL CHARACTERISTICS**
**(TA=25°C)**

Parameter	Symbol	Test Condition	Value			Unit
			Min	Typ	Max	
Luminous Intensity	I <sub>V</sub>	I <sub>F</sub> = 20mA	1000	1300	-	mcd
Forward Voltage	V <sub>F</sub>	I <sub>F</sub> = 20mA	-	2.0	2.4	V
Reverse Leakage Current	I <sub>R</sub>	V <sub>R</sub> = 5V	-	-	10	μA
Viewing Angle	2θ <sub>1/2</sub>	I <sub>F</sub> = 20mA	-	30	-	deg
Peak Wavelength	λ <sub>P</sub>	I <sub>F</sub> = 20mA	-	660	-	nm
Dominant Wavelength	λ <sub>D</sub>	I <sub>F</sub> = 20mA	-	645	-	nm
Spectral Line half-width	Δλ	I <sub>F</sub> = 20mA	-	25	-	nm

\*Tolerance of viewing angle: -10 / +5 deg.



ChromeLED Corp. reserves the right to make changes at any time in order to supply the best product possible. The most current version of this document will always be available at: [www.chromeled.com](http://www.chromeled.com)

## OPTICAL CHARACTERISTIC CURVES

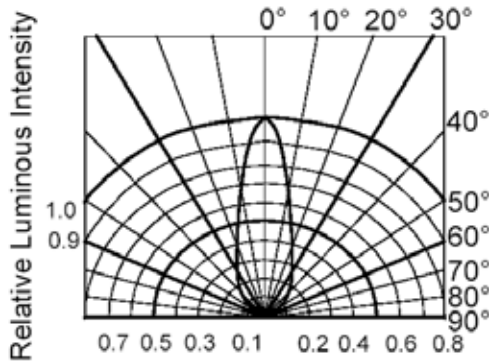

**RADIATION DIAGRAM**

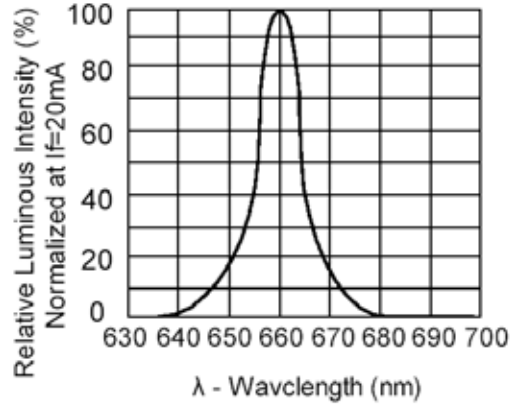

**RELATIVE LUMINOUS INTENSITY Vs. WAVELENGTH**

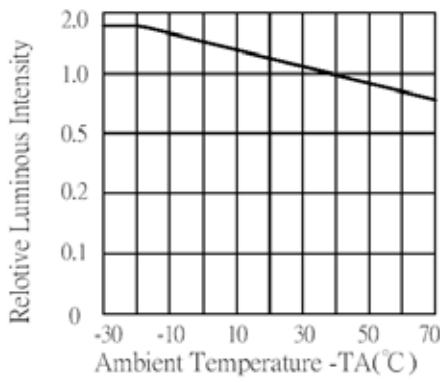

**LUMINOUS INTENSITY Vs. AMBIENT TEMPERATURE**

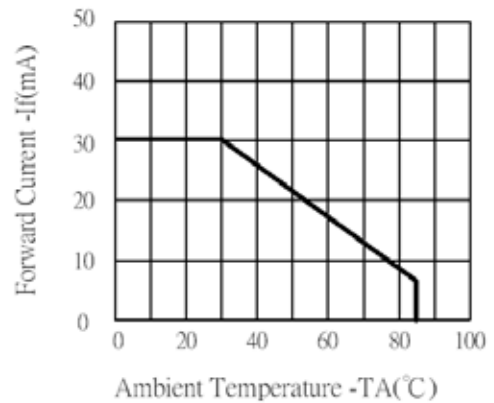

**FORWARD CURRENT Vs. AMBIENT TEMPERATURE**

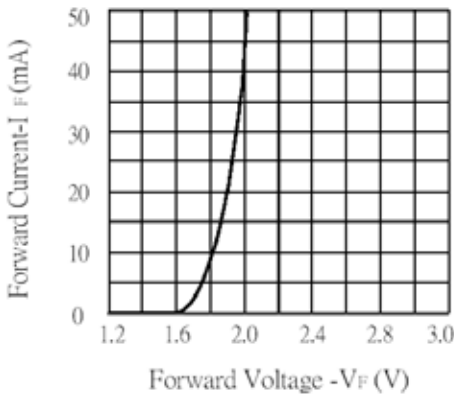

**FORWARD CURRENT Vs. FORWARD VOLTAGE**

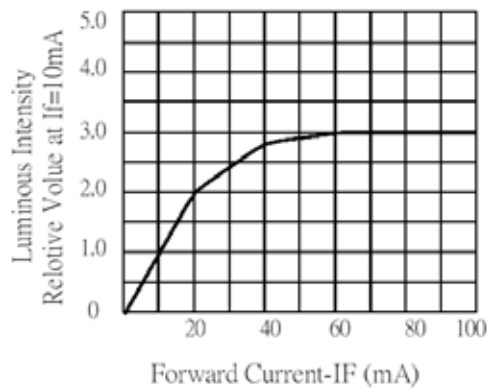

**LUMINOUS INTENSITY Vs. FORWARD CURRENT**



ChromeLED Corp. reserves the right to make changes at any time in order to supply the best product possible. The most current version of this document will always be available at: [www.chromeled.com](http://www.chromeled.com)

## SOLDERING CONDITIONS – LAMP TYPE LED

\* Solder the LED no closer than 3mm from the base of the epoxy bulb. Soldering beyond the base of the tie bar is recommended.

\* Recommended soldering conditions

Dip Soldering	
Pre-Heat	100 °C Max
Pre-Heat Time	60 Second Max
Solder Bath Temperature	260 °C Max
Dipping Time	5 Second Max
Dipping Position	No lower than 3mm from the base of the epoxy

Hand Soldering		
	3mm Series	Others
Temperature	300 °C Max	350 °C Max
Soldering Time	3 Second Max	3 Second Max
Position	No closer than 3mm from the base of the epoxy	No closer than 3mm from the base of the epoxy

\* Do not apply any stress to the lead. Particularly when heated.

\* The LED must not be repositioned after soldering.

\* After soldering the LEDs, the epoxy bulb should be protected from mechanical shock or vibration until the LEDs return to room temperature.

\* Direct soldering onto a PC board should be avoided. Mechanical stress to the resin may be caused by the PC board warping or from the clinching and cutting of the leadframes. When it is absolutely necessary, the LEDs may be mounted in this fashion, but, the user will assume responsibility for any problems. Direct soldering should only be done after testing has confirmed that no damage, such as wire bond failure or resin deterioration, will occur. LEDs should not be soldered directly to double sided PC boards because the heat will deteriorate the epoxy resin.

\* When it is necessary to clamp the LEDs to prevent soldering failure, it is important to minimize the mechanical stress on the LEDs.

\* Cut the LED leadframes at room temperature. Cutting the leadframes at high temperature may cause LED failure.



ChromeLED Corp. reserves the right to make changes at any time in order to supply the best product possible. The most current version of this document will always be available at: [www.chromeled.com](http://www.chromeled.com)