

SPECIFICATION
CSHF1311W3C40
PACKAGE OUTLINES

Notes:

1. All dimensions are in millimeters (inches).
2. Tolerance is $\pm 0.25\text{mm}$ (0.01") unless otherwise noted.
3. Specifications are subject to change without notice.

Part Number	Chip Material	Color of Emission	Lens Type	Viewing Angle
CSHF1311W3C40	InGaN	Green	Water Clear	120°

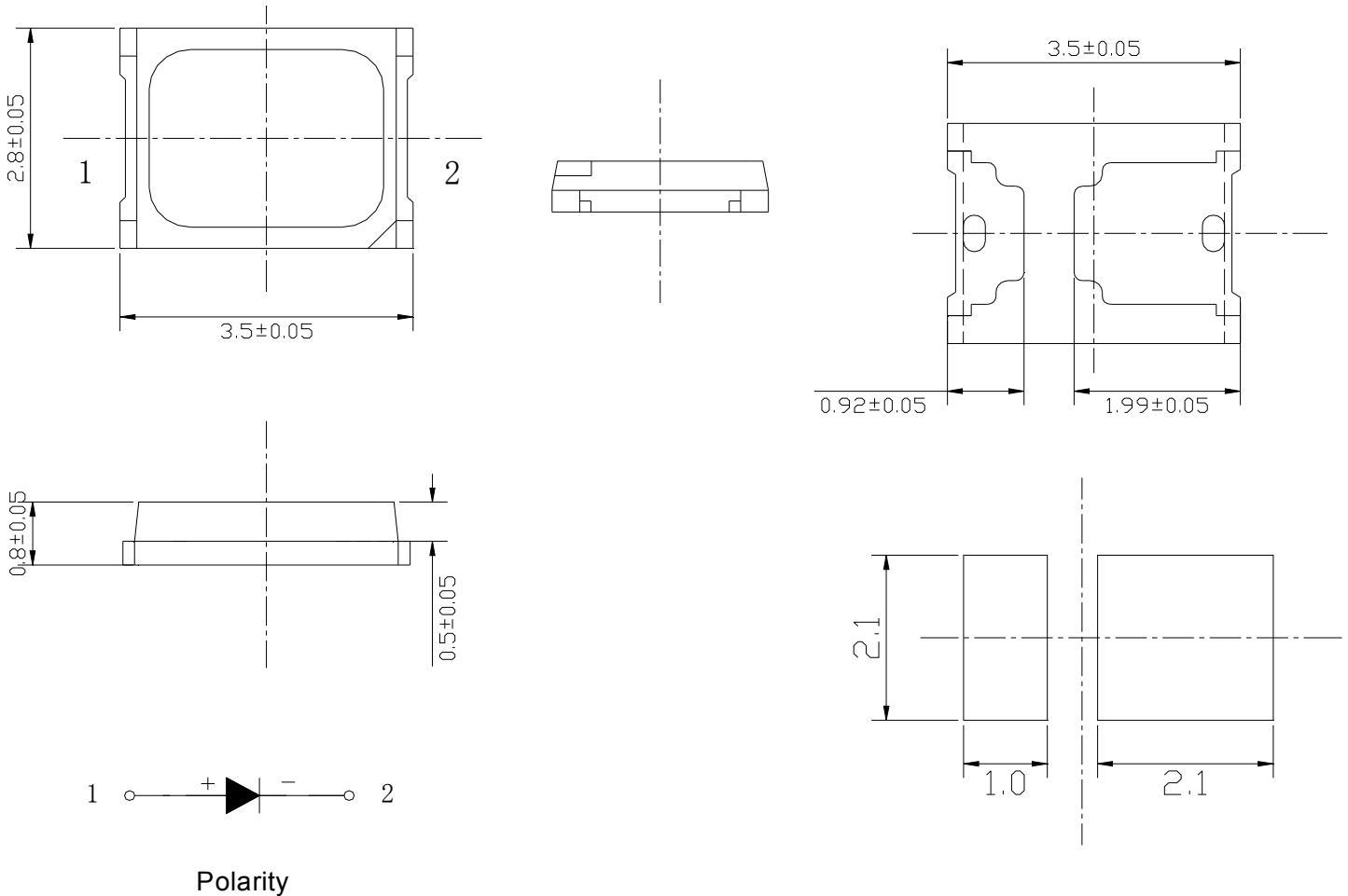

ChromeLED Corp. reserves the right to make changes at any time in order to supply the best product possible. The most current version of this document will always be available at: www.chromeled.com

ABSOLUTE MAXIMUM RATINGS
(TA=25°C)

Parameter	Symbol	Max Rating	Unit
Forward Current	IF	60	mA
Reverse Current @ 5V	IR	10	μA
Operating Temperature Range	TOP	-40~+85	°C
Storage Temperature Range	TSTG	-40~+100	°C
Peak Pulsing Current (1/10 duty f = 10KHz)	IFP	120	mA
Soldering Temperature	TSOL	Max 260°C for 5 sec Max	

OPTICAL-ELECTRICAL CHARACTERISTICS
(TA=25°C)

Parameter	Symbol	Test Condition	Value			Unit
			Min	Typ	Max	
Luminous Intensity	Iv	IF = 60mA	24	26	-	lm
Forward Voltage	VF	IF = 60mA	-	2.9	3.2	V
Reverse Leakage Current	IR	VR = 5V	-	-	10	μA
Viewing Angle at 50% Iv	2θ1/2	IF = 60mA	-	120	-	Deg
Color Rendering Index	CRI	IF = 60mA	90	92	-	-
Correlated Color Temperature	CCT	IF = 60mA	3700	-	4275	K

*Tolerance of viewing angle: -10 / +5 deg.



ChromeLED Corp. reserves the right to make changes at any time in order to supply the best product possible. The most current version of this document will always be available at: www.chromeled.com

OPTICAL CHARACTERISTIC CURVES

Fig.1-Forward Voltage Vs. Forward Current
伏安特性曲线

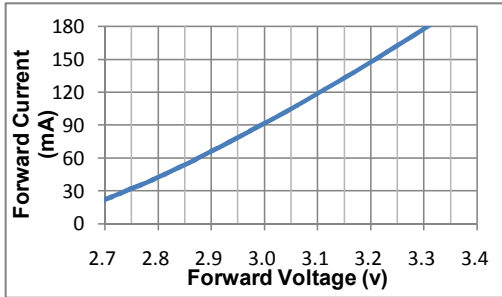

Fig.2-Forward Current Vs. Relative Intensity
正向电流与相对光强特性曲线

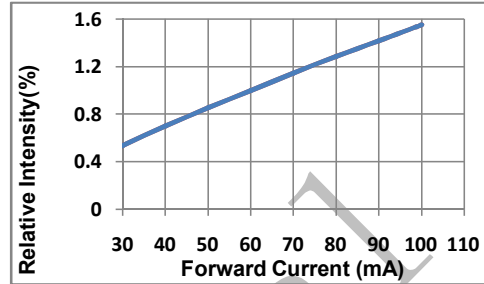

Fig.3-Ambient Temperature Vs. Relative Intensity
环境温度与相对光强特性曲线

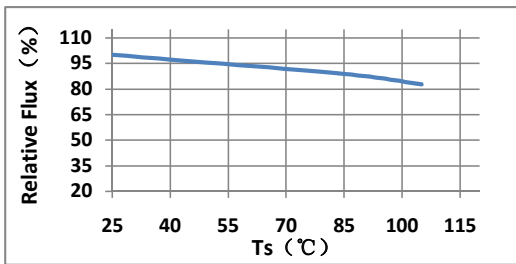

Fig.4-Ambient Temperature Vs. Forward Current
环境温度与正向电流特性曲线

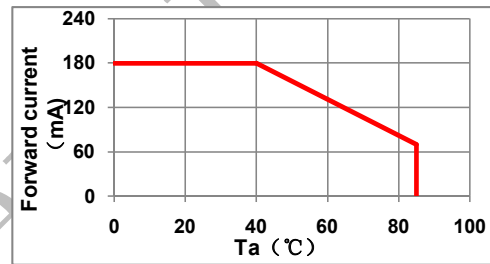

Fig.5-Forward Voltage Vs. Ambient Temperature
电压与环境温度特性曲线

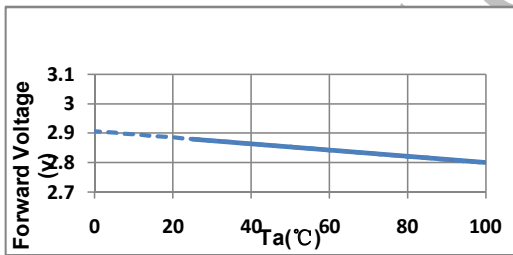

Fig.6-Radiation diagram
辐射特性曲线

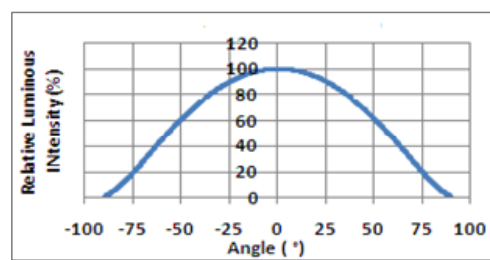

Fig.7-Chromaticity Coordinate Vs. Ambient Temperature
色坐标与环境温度特性曲线

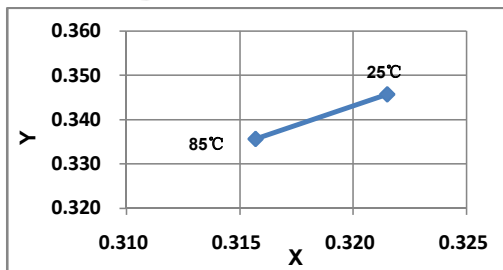
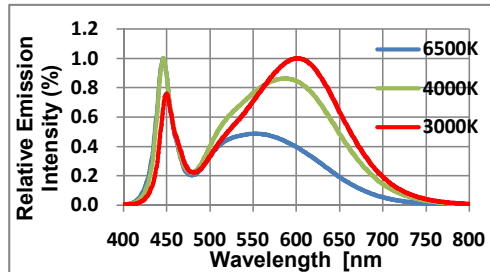

Fig.8- Spectrum Distribution
光谱分布特性曲线



ChromeLED Corp. reserves the right to make changes at any time in order to supply the best product possible. The most current version of this document will always be available at: www.chromeled.com

SOLDERING CONDITIONS

Reflow profile

- Soldering condition
 - Recommended soldering conditions

Reflow Soldering		Hand Soldering	
Pre-heat	160~180°C	Temperature	300°C Max.
Pre-heat time	120 seconds Max.	Soldering time	3 second Max. (one time only)
Peak temperature	260°C Max.		
Soldering time	10 seconds Max.		
Condition	Refer to Temperature-profile		

- After reflow soldering rapid cooling should be avoided
- Temperature-profile (Surface of circuit board)
Use the following conditions shown in the figure.

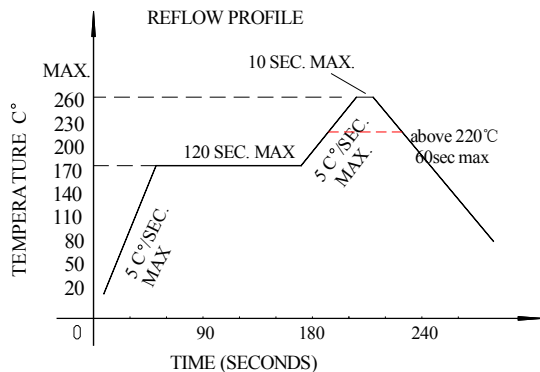

1. Reflow soldering should not be done more than two times
2. When soldering, do not put stress on the LEDs during heating

■ Soldering iron

1. When hand soldering, keep the temperature of the iron under 300°C, and at that temperature keep the time under 3 sec.
2. The hand soldering should be done only a time
3. The basic spec is ≤5 sec. when the temperature of 260°C, do not contact the resin when hand soldering

■ Rework

1. Customer must finish rework within 5 sec under 260°C
2. The head of iron can not touch the resin
3. Twin-head type is preferred.

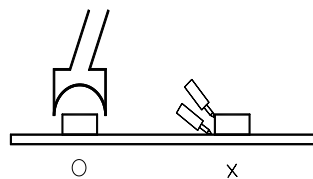

ChromeLED Corp. reserves the right to make changes at any time in order to supply the best product possible. The most current version of this document will always be available at: www.chromeled.com